

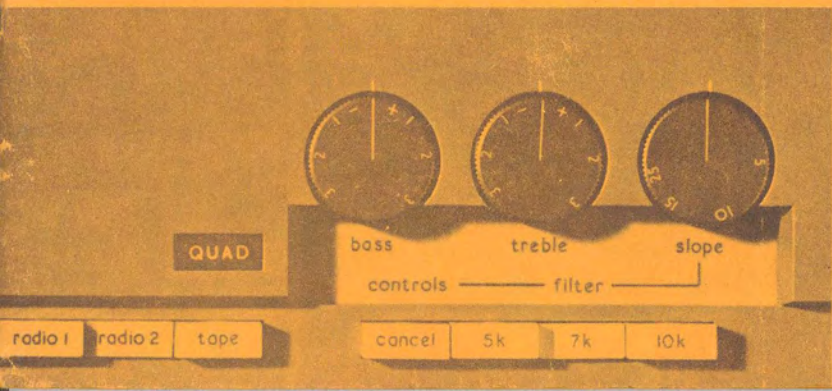

# QUAD 33-303 instruction booklet



## Contents

	Page
Introduction ... ..	2
Installation ... ..	3
Mounting the units ... ..	4 & 5
Connections ... ..	6 to 10
Pickup (Disc) Adaptor ... ..	7
Tape Adaptor ... ..	10
Initial Checks and Operation ... ..	13
Controls ... ..	13 to 15
Loudspeaker phasing ... ..	15
Loudspeaker position ... ..	17
Operation Summary ... ..	18
Service ... ..	18
Specifications ... ..	19 to 23
Guarantee ... ..	24

## Illustrations

	Page
Installation Schematic ... ..	3
Pickup and motor wiring ... ..	3
Mounting the Quad 33 ... ..	4
Connections to Quad 303 ... ..	5
DIN plugs ... ..	6
DISC input ... ..	7
Disc Adaptor Board ... ..	8
Tape and Radio inputs ... ..	8
Tape Adaptor Board ... ..	9
Tape Adaptor adjustments ... ..	10
Quad 33 rear panel layout ... ..	11
Quad 33 controls ... ..	12
Quad 33 performance curves ... ..	16
Quad 303 performance curves ... ..	23

THE ACOUSTICAL MANUFACTURING CO. LTD.

ST. PETERS ROAD, HUNTINGDON, ENGLAND

Telephone: Huntingdon (0480) 2561

Telegrams: Acoustical Huntingdon

**QUAD**

**for the closest**

**approach to the**

**original sound**

## INTRODUCTION

This amplifier has been designed to provide the best possible quality of reproduction but it must be borne in mind that the standard of performance of the complete equipment will be limited by that of the poorest link in the chain. Thus, the gramophone motor, pickup, loudspeaker, etc., should all receive careful consideration if full advantage is to be taken of the capabilities of the amplifier.

A complete installation is shown in Fig. 1 and the same basic arrangement will apply in whole or in part, whatever associated equipment is used with the Quad 33. Installation is quite straightforward and should present no difficulty to the intelligent enthusiast provided the following notes are observed.

Please note that three printed circuit boards from the Quad 33 are packed separately for safe transit. These must be inserted during installation. See Fig. 3 and also instructions contained in the packing.

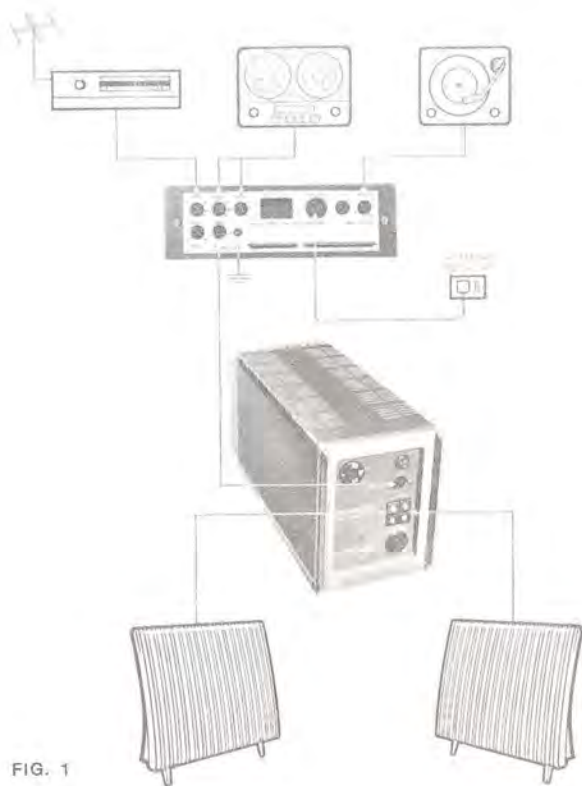

FIG. 1

## INSTALLATION

Normally equipment of this type may be either mounted in a wide variety of housings or used free-standing, and if you are designing your own layout it might be advisable to assemble all the parts in a mock-up form before deciding on the final arrangement, just to make sure there are no unforeseen difficulties of operation or inter-unit wiring, etc.

Adequate ventilation must be provided for units producing heat, including transistorised power amplifiers and if the latter are to be mounted closer than about 12 inches from either control unit or tuner it might be necessary to experiment with orientation and position to ensure that no hum is induced in the latter units.

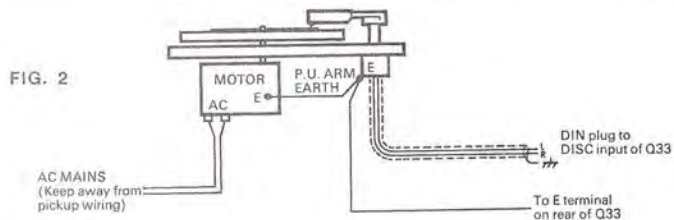

FIG. 2

Close proximity of the control unit and tuners to each other should cause no problem unless the control unit is mounted immediately on top of the tuner, in which case a space of about two inches should be left between them.

Hum can also occur if a low output magnetic pickup is too close to a mains transformer or if its leads run close to the mains wiring. (See Fig. 2).

All metal parts must be earthed but, because multiple earth connections cause hum, they should be earthed, directly or indirectly, by one connection only, and the whole installation earthed at one point such as the E terminal on the rear of the control unit, OR the third pin of the control unit mains socket, but not both.

(Note: All the Quad units are already bonded together by their own inter-connecting cables).

Always follow the manufacturers' instructions supplied with pickup, motor, tape recorder, etc., and refer any query which may arise to your dealer or in case of difficulty to the manufacturer concerned.

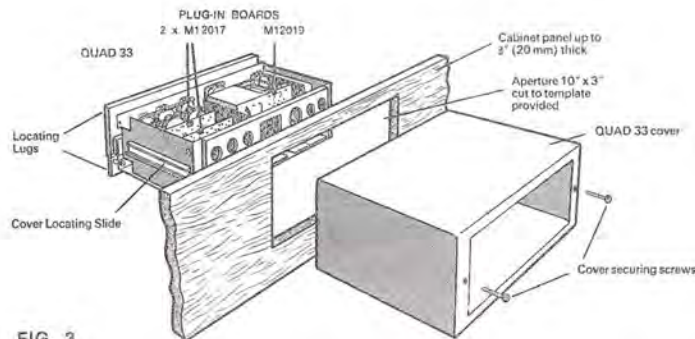

FIG. 3

If the Quad 33 is not to be used free standing you will require an aperture 10" x 3" as shown in Fig. 3 and a template is provided in the rear of this booklet to assist in marking this out on the cabinet. The cover is then removed from the Quad 33, the unit passed through the aperture from the front so that its lugs locate in the aperture, and the cover replaced from the rear, thus gripping the cabinet panel between the Quad 33 front casting and its cover. The securing screws should be inserted finger tight and then given one further half-turn to lock the unit firmly in position.



FIG. 4

The Quad 303 carries no controls and may be mounted out of sight inside the cabinet or at any other convenient position in the installation.

The Quad 303 may be either stood on its feet on a shelf or base board of a cabinet, or more securely fixed by drilling four holes in the shelf or board to coincide with the feet centres, removing the feet securing screws and passing the longer screws provided, up through these holes, through the feet which act as spacers to assist circulation of air under the amplifier, and into the tapped bushes in the base-plate.

Slots or holes should be cut in or near the base and in or near the top of any enclosed compartment to permit a flow of air upwards through the compartment, past and through the amplifier to assist ventilation. In confined spaces where the exit vents are not directly over the amplifier a deflector plate of plywood or asbestos may be mounted at an inclined angle above the amplifier to help guide the rising warm air towards the exit vent and prevent an accumulation of warm air under a closed horizontal top.

## CONNECTIONS

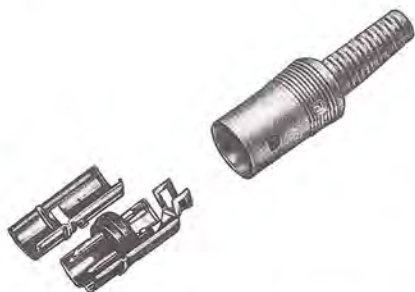
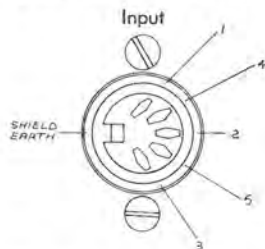

Din style plugs showing method of assembly. See individual illustrations for pin connections.

### Control Unit to Power Amplifier

Two leads are supplied with the control unit. That with a 4-pin connector at each end is reversible and connects the control unit output to the power amplifier input. The other connects the switched mains supply from the control unit to the power amplifier and the 2-pin plug at the control unit end of this lead is reversible. (See Fig. 10). Longer leads are permissible where required for special installations (see Specification on page 21).

*Page Six*

### Power Amplifier to Loudspeakers

Ordinary lighting flex or similar cable may be used for connecting the loudspeakers to the power amplifier unless a very long run is involved in which case a heavier calibre cable should be used. As a rough guide the DC resistance of the cable should not exceed about 5% of the nominal impedance of the loudspeaker. Each loudspeaker should be connected to its appropriate power amplifier output so that the two pairs of wires are connected in the same way, to ensure that the speakers operate in phase. For example, if the top output socket on one channel is connected to the left-hand terminal of its speaker, the top output socket on the other channel should also be connected to the left-hand terminal of its speaker. This is quite straightforward but should there be any doubt the phasing can be checked later experimentally. (See Page 15). Where one loudspeaker only is used for mono, phase is not important and in this case either outlet may be used and the sockets of the other channel left vacant.

In cases where loudspeakers, such as the electrostatic loudspeaker, also require an energising supply, the

instructions provided with the loudspeaker should be followed. Each loudspeaker should be capable of handling the full output of the power amplifier.

**Note:** *Quad electrostatic loudspeakers prior to serial number 16800 need slight modification before being used with the Quad 303 amplifier.*

### Pickup (Disc) Input

The pickup input is via a 5-pin plug and the same connections are used for all types of pickup. The necessary change in input circuitry to suit different types of pickup is achieved by the Disc Adaptor Board. This board provides matching for pickups of low output magnetic types (M1), high output magnetic types (M2), ceramic types (C1), and a spare position (S1), according to the edge inserted into the holder. (See Specification on Page 20).

The M2 position should normally be used for most magnetic pickups but for those with very low outputs M1 should be used instead.

The fourth position is to enable the amateur or professional engineer to provide any other circuit configuration he may require and it also provides, of course, facility for accommodating any new type of pickup which may be introduced, requiring a different input from existing types.



FIG. 5



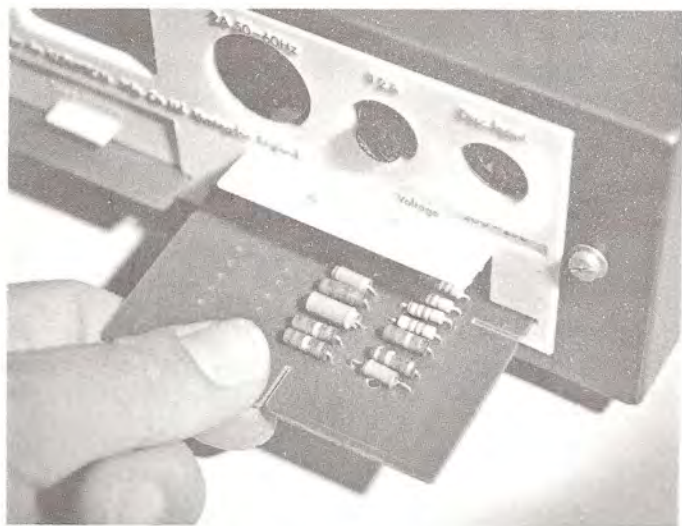

FIG. 6 DISC ADAPTOR BOARD

### Radio (See Fig. 7)

Sockets are provided on the Quad 33 for two radio tuners to be connected. For example, an FM tuner, used for mono or stereo, may be connected to Radio 1

input and an AM tuner for long distance reception to Radio 2. Quad self-powered tuners are supplied with the correct connectors and may be plugged in immediately. The connectors used on other self-powered tuners should be adapted as necessary and those already fitted



FIG. 7

with the same type of plug should be checked to ensure that the same connections are used. The output of such tuners should be suitable for the Quad 33 input of 100mV and 100K ohms (stereo) or 100mV and 50K ohms (mono).

The mains supply for these tuners should also be taken from the mains outlet sockets at the rear of the Quad 33. (See Fig. 10).

**WARNING**

*On no account should the HT/LT lead of earlier Quad tuners be connected to the power supplies sockets of the Quad 33 control unit. If such tuners are used a separate power pack must be provided.*

## Tape

Three essential functions are provided for tape recording:

- (1) to provide a signal of the right level for recording, not affected by any of the tone, filter or volume controls and without affecting normal listening;
- (2) to accept a signal of any likely level from the recorder for replay and subject this to all the appropriate control facilities, and



FIG. 8

TAPE ADAPTOR BOARD

- (3) to monitor the signal off the tape during recording without interrupting the recording operation, providing, of course, that the tape recorder has a monitor output.

The plug-in Tape Adaptor Board provides three alternative signal level settings each for recording and replay on both channels, by means of small screws inserted from the underside of the board into the appropriate position for the signal level of the tape recorder to be used. (See Fig. 9 and Specification on Pages 20 and 21).

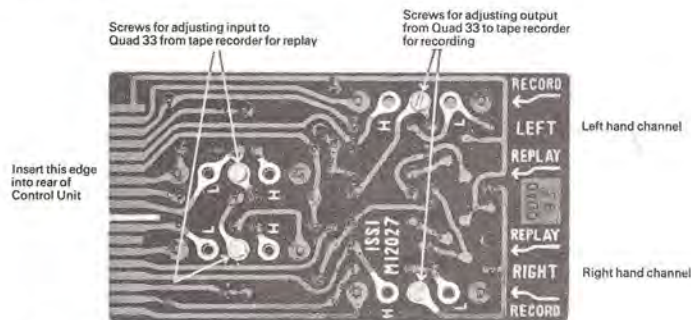

FIG. 9

Normally either one or both tape sockets may be used for recording and replay as convenient, the (L) and (R) pins (See Fig. 7) of the record socket being linked inside

the control unit to the corresponding pins of the replay socket. Where the levels and impedances are such that cross-talk can appear in the cables and connectors it will be advisable to use completely separate connections for recording and replay.

### Mains Outlets

These sockets are intended for supplying the Quad 303 power amplifier and the FM stereo tuner. Normally it will be more convenient to run the mains supply direct to tape recorder and gramophone motor since these incorporate their own on/off switching, but if other units are run off the Quad 33 mains outlets the total current drawn must not exceed 2 amps.

### Mains Input

A 3-pin connector is provided for the control unit and this should be wired to the mains supply using a suitable grade of flexible cable. In countries where an earth connection is not used or where an external earth is connected to the E terminal of the control unit the third pin of the plug should be left blank.

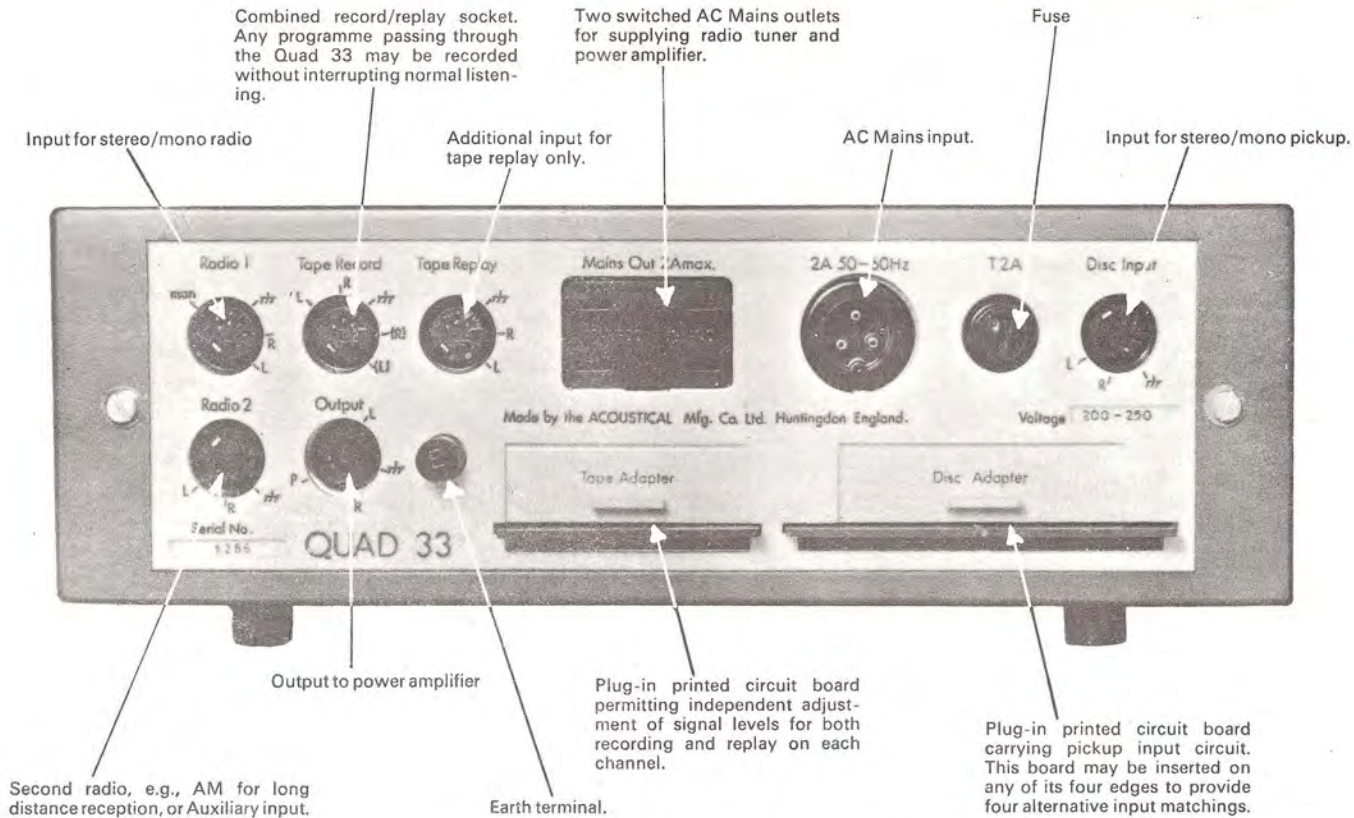

FIG. 10

All signal connections comply with the internationally used DIN standards.

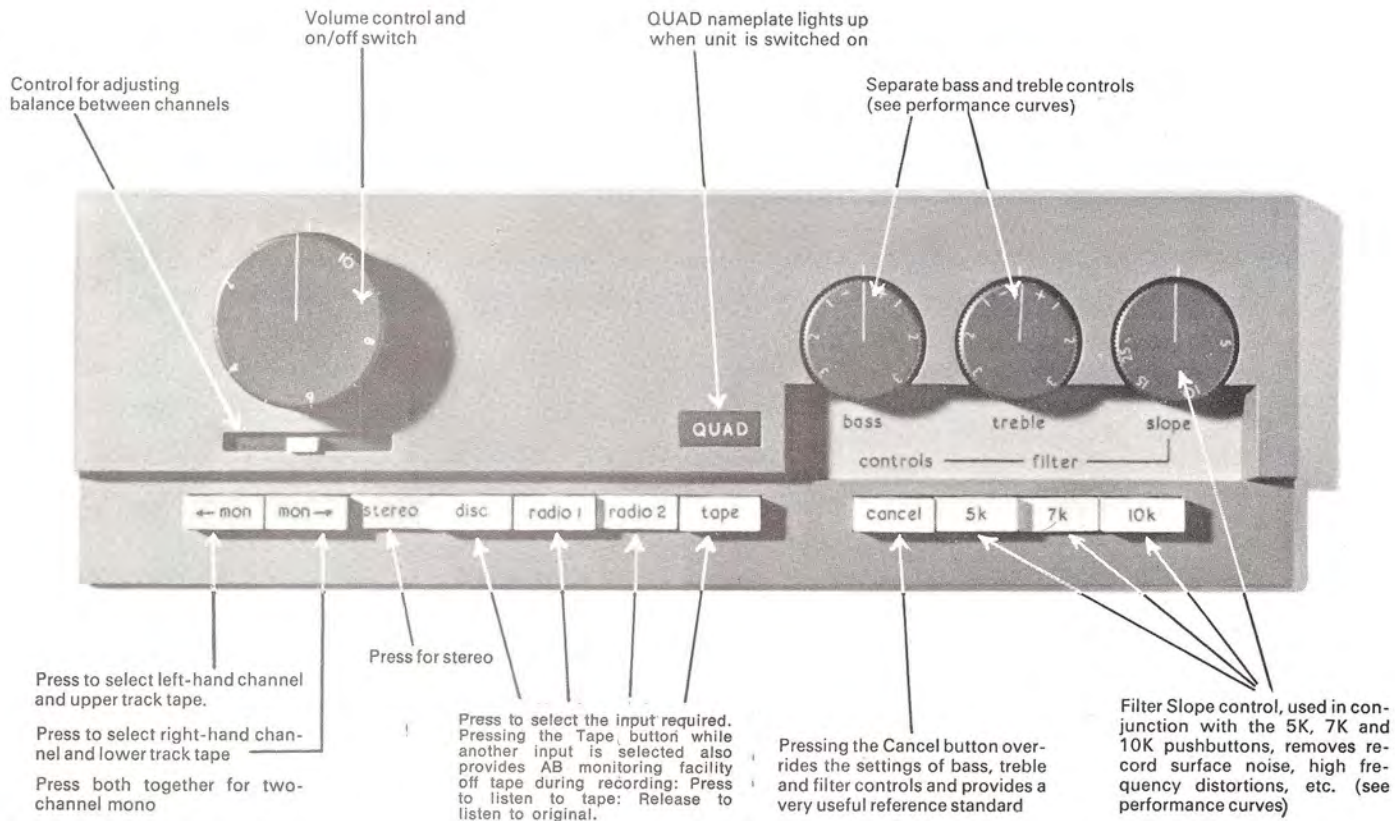

FIG. 11

## INITIAL CHECKS AND OPERATION

Before connecting the mains supply, ensure that the voltage marked on the rear of the control unit and the setting of the selectors on the power amplifier and tuner are correct for your mains. These selectors are set by withdrawing the cap  $\frac{3}{8}$ "', rotating it to the required voltage and pushing it fully home again. Then connect the mains and rotate the volume control to switch on the equipment. The Quad 33 nameplate, the Quad 303 indicator light and the tuner scale should now light up.

### Pushbuttons (see also Filters)

The input (Radio 1, Radio 2, Tape replay or Disc) and the service (Stereo, or Mono on left-hand speaker, right-hand speaker or both), are selected by pressing the appropriate pushbuttons.

With Stereo pressed, all inputs are connected for stereo reproduction. In the case of radio, the tuner will automatically switch to Stereo when a stereo signal is received, reverting to Mono at all other times.

Pressing either or both of the Mon buttons will

reproduce a mono signal from Disc or Radio 1 whether the programme source is mono or stereo. With Radio 2 or Tape inputs, however, apart from selecting loudspeakers, the Mon buttons also select left or righthand inputs, each to its own speaker. In addition,\* either input may be reproduced over both speakers by pressing the Stereo buttons as well as the ←Mon or Mon→ button and, of course, Radio 2 or Tape.

*\* This facility was not available prior to serial number 7500.*

### Volume Control

The volume control is advanced to the appropriate level, bearing in mind that apart from enabling a level of sound to be obtained which suits the listening conditions of the moment, the volume control also has the important function of adjusting the intensity of sound so that it is correctly related to the perspective of the recording or broadcast. This is obviously important for realistic reproduction.

For example, if a voice is picked up close to a microphone in a very absorbent studio, then on repro-

duction that voice will take up a position at the centre of, and in the plane of the loudspeakers. For natural sound, therefore, the loudspeakers should radiate similar power to that of the original voice. If on the other hand the voice is picked up some way from the microphone in a more live studio, then the voice on reproduction will take up a position some distance behind the loudspeakers and it is clear that the power required for natural sound is now very much less. The position or perspective of the reproduced sound is fixed at the studio end and there is little that can be done at the listening end to alter it. It follows that the volume setting for natural sound is to a large extent fixed at the studio end.

**Filters** (See page 16).

The filters affect the extreme harmonic range only and do not interfere with musical brilliance. Their purpose is to enable the maximum content of the programme to be reproduced with the minimum distortion.

With most types of recording the distortion rises

rapidly at high frequencies and the wider the loudspeaker range the more audible this will be. It may be removed or mitigated by rotating the filter slope control anti-clockwise from the level position. As the control is rotated, the quality and "cleanness" of the reproduction will improve. There will, however, be a point beyond which further rotation degrades the sound due to loss of the useful harmonic range.

The pushbuttons marked 5K, 7K and 10K, determine the frequency at which filtering commences and that marked 7K is the most useful for modern recordings. Pressing the 5K pushbutton transposes the filter operation to a lower frequency for use with older recordings and pressing the 10K pushbutton transposes it to a higher frequency where it is useful with very good records or high quality radio transmissions.

The Cancel button bypasses the bass, treble and filter controls to give a level response. This position is a reference by which the effects of the settings of the other controls may be judged without upsetting the position of these controls.

## Balance Control

This merely adjusts the balance of the two channels and after initial adjustment it should require no alteration for normal listening unless a misbalanced recording or broadcast is to be reproduced, which is unusual, or unless the position of the loudspeakers or their environment is changed.

## Bass and Treble Controls (See page 16).

The musical balance of a programme is carefully adjusted during recording or broadcasting and adjustment of the bass and treble controls should not normally be necessary unless an inferior loudspeaker or the listening environment produces some effect which needs correction. Once set for a particular installation, therefore, these controls should be little used. Small deviations of the bass control will affect very low notes only. Greater deviations affect not only the very low notes to a greater extent but also the high bass notes. The treble control affects brilliance.

## Loudspeaker Phasing

If, for any reason, there is any doubt about the way in which the loudspeakers are connected (see page 6) their phasing may now be checked by playing a mono disc over both channels, when the sound should appear to emanate from a point midway between them. If this is indefinite the connections to either of the loudspeakers, but not both, should be reversed. Correctly connected the speakers will give a definite centre sound source accompanied by a more full bodied sound in the tenor and bass registers.



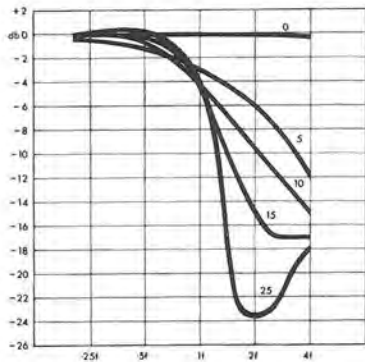

As the Filter slope control is rotated from 0 to 25 the filter swings from a level response to a steep cut as shown, f is the frequency selected by the 5kHz, 7kHz or 10kHz push buttons.

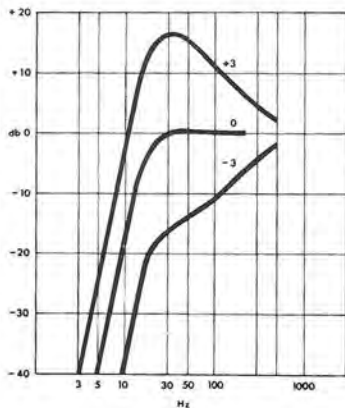

All sub-audio signals below 20Hz are drastically filtered as shown. The three curves correspond to minimum, level and maximum settings of the Bass control.

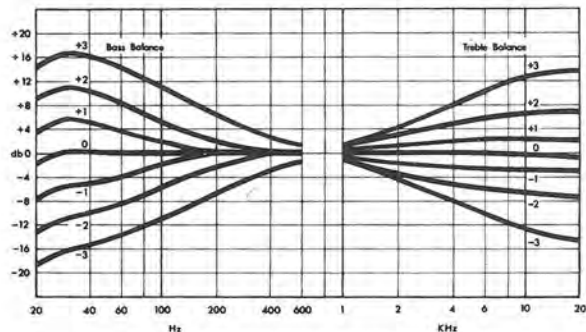

The Bass & Treble controls provide smooth and independent adjustment of the response to suit programme or environment

### QUAD 33 PERFORMANCE CURVES

## Loudspeaker Position

The standard of reproduction obtained from any loudspeaker is influenced by both its position in the room and its position in relation to the listening area. The optimum position can only be found by experiment and this cannot be carried out quickly or in a perfunctory manner, if long term non-fatiguing listening is to be obtained.

It is a fact that the standard of reproduction in many homes, both mono and stereo, is significantly below that which could have been obtained had sufficient attention been paid to loudspeaker positioning. Broadly, for stereo the two loudspeakers should be 6ft. to 8ft. apart with the listener at a similar distance from each. Clearly, when more than one person is listening they cannot both occupy the same position and all listening tests should aim at obtaining good stereo over a reasonable area.

This can usually be achieved over an area immediately behind the listening point already defined, with a width equal to the distance between loudspeakers and with a similar depth. Outside this area the overall quality

should be satisfactory although the perspective may be degraded. The measurement of 6ft. to 8ft. is based on a small room. With a larger room the scale may be increased accordingly.

The quality of the results obtained will depend upon the following:—

- (a) The position of the loudspeakers with respect to the room boundaries (and sometimes floor joists).
- (b) The direction of loudspeaker axis.
- (c) The position of large pieces of furniture.

With stereo the following may be added:—

- (d) The distance apart.
- (e) The point of intersection of the loudspeaker axes.
- (f) The relation of the base line (an imaginary straight line joining the two speakers) to the room boundaries.
- (g) The position of the listeners.

The instructions supplied with the loudspeaker may resolve some of the variables and the rest must be solved

by experiment. Few people can successfully complete these experiments at a single session and it is strongly recommended that the following procedure be adopted.

The loudspeaker(s) should be tried in the various room positions which appear physically possible, in order to ascertain which positions are likely to be worth further investigation.

The loudspeaker should now be used in each of these positions for normal day to day listening. The usual attention should be paid to the programme itself without any conscious concentration on the quality. In this way the optimum position for most satisfactory listening will soon become apparent.

## OPERATION SUMMARY

With all the tests detailed in the previous section completed, operation of the Quad 33 should now be readily apparent and completely straightforward. It may be summarised as follows:—

Use the pushbuttons to select input and system required.

Adjust the volume control for a level of sound suitable for the programme.

Adjust the filter to obtain the best quality inherent in the programme remembering that this means filtering as little as possible.

Adjust bass and treble controls only if it is necessary to alter the musical balance of the programme.

Adjust the balance control only if the programme levels of the two channels are themselves out of balance.

## SERVICE

Normally the dealer supplying the equipment will be able to assist with advice or any attention the equipment may require but in case of difficulty you should return any Quad unit you wish to have checked, direct to our Service Department, or that of our main agent in the country concerned, carriage paid and preferably packed in its original carton. If this is not available a pack will be forwarded on request.

Do not forget to enclose a note giving your name and address, full details of the reason for returning the unit and all the symptoms you have observed.

## SPECIFICATION FOR QUAD 33 CONTROL UNIT

<b>DISTORTION:</b>	All controls level, 0.5Vrms output, with any input.	: 0.02% )	} 30-10,000 Hz
	Any control settings and any level within overload ratings	: 0.1% )	
<b>RESIDUAL NOISE:</b>	0-30 phon weighting 15.7kHz bandwidth controls level or cancel	: -90dB	
<b>FREQUENCY RESPONSE:</b>	Any input, any output RIAA or flat as appropriate	: $\pm 0.5\text{dB}$	30-20,000 Hz
<b>TONE CONTROLS:</b>	$\pm 1\text{dB}$ of published curves (see page 16)		
<b>FILTERS:</b>	To published curves at 5kHz, 7kHz and 10kHz $\pm 5\%$ (see page 16)		
<b>INTER-CHANNEL BALANCE:</b>	Within 1dB with volume control varied from maximum to -45db		
<b>BALANCE CONTROL RANGE:</b>	9dB either way		
<b>CROSSTALK:</b>	Dependant on input source impedances. Replay/record typically better than 70dB 30-10,000 Hz Interchannel typically better than 40dB 30-10,000 Hz		

SPECIFICATION FOR QUAD 33 CONTROL UNIT  
 INPUTS (all voltages rms)

		<b>Recommended Source Impedance</b>  1.	<b>Load Impedance</b>  2.	<b>Input Level for 0.5V Main Output</b>  3.	<b>Maximum Input</b>  4.	<b>Signal to noise referred to level in Col. 3 0-30 phon weighting</b>
<b>RADIO</b>		20K ohms or less	100K ohms	100mV	2V	85dB
<b>TAPE REPLAY</b>	H	any	40K ohms	1V	10V	85dB
	M	any	40K ohms	400mV	4V	85dB
	L	any	40K ohms	100mV	1V	85dB
<b>DISC</b>	M1	Low Output Magnetic 0.5-2mV/Cm/Sec.	68K ohms	2mV at 1kHz	40mV at 1kHz	70dB
	M2	High Output Magnetic 1.5-6mV/Cm/Sec.	68K ohms	5.6mV at 1kHz	120mV at 1kHz	80dB
	C1	Ceramic 450-800pF 25-80mV/Cm/Sec.	Special	100mV at 1kHz	1.2V at 1kHz	
	S	<b>FOR SPECIAL REQUIREMENTS</b>				

**SPECIFICATION FOR QUAD 33 CONTROL UNIT  
OUTPUTS (all voltages rms)**

		Level	Source Impedance	Recommended Load Impedance	Maximum Cable Lengths — (Using 20pF/ft Screened Lead)
<b>TO POWER AMPLIFIER</b>		0.5V	1K ohms	10K ohms or over	100 feet
<b>TO TAPE RECORDER</b>	H	100mV *	5K ohms	25K ohms or over	150 feet
	M	20mV *	800 ohms	any	any
	L	3.7mV *	180 ohms	any	any

\* 30% programme modulation

**WEIGHT:** 6½ lb. (3Kg.)

**DIMENSIONS:** Width 10¼" (260mm)  
 Height 3⅝" (92mm) free standing, 3¼" (83mm) panel  
 Depth 6½" (165mm) free standing  
 5½" (140mm) behind cabinet panel when mounted  
 (Allow a further 2½" (64mm) beyond rear panel for connectors)

**POWER INPUT:** 100-130/200-260V 50-60 Hz 1.5 Watts.

## SPECIFICATION FOR QUAD 303 POWER AMPLIFIER

The figures and curves refer to measurements on either channel,  
with or without the other channel operating.

### POWER OUTPUT AND DISTORTION

(with unrestricted bandwidth)

70 Hz	0.03%		Any level up to 28W 16 ohms load Any level up to 45W 8 ohms load
700 Hz	0.03%		
10 kHz	0.1%		

### FREQUENCY RESPONSE:

—1dB (ref: 1kHz) at 30 Hz and 35kHz into 8 ohms  
—1dB (ref: 1kHz) at 20 Hz and 35kHz into 16 ohms

### OUTPUT SOURCE IMPEDANCE:

0.3 ohms in series with 2000 $\mu$ F and 6 $\mu$ H.

### INPUT LEVEL:

0.5V rms for 30 watts into 16 ohms

### INPUT IMPEDANCE:

22K ohms in parallel with 60pF

### HUM AND NOISE:

—100dB below full output

### INTERCHANNEL CROSSTALK:

30–10,000 Hz better than 60dB. Input load 1 K ohms.

### STABILITY:

unconditionally stable with any load.

### POWER INPUT:

100–125 or 200–250V 50–60 Hz.  
40–200 watts depending on signal level.

### WEIGHT:

18 lb. (8.2Kg.)

### DIMENSIONS:

Width 4 $\frac{3}{4}$ " (120mm.)  
Height 6 $\frac{1}{4}$ " (159mm.)  
Depth 12 $\frac{3}{4}$ " (324mm.)  
(plus 1 $\frac{1}{4}$ " (38mm.) for connectors).

### OTHER APPLICATIONS:

The amplifier may be used for any purposes into load impedances greater than 8 ohms. Below 8 ohms applications should be restricted to music and speech reproduction or intermittent sine-wave duty.

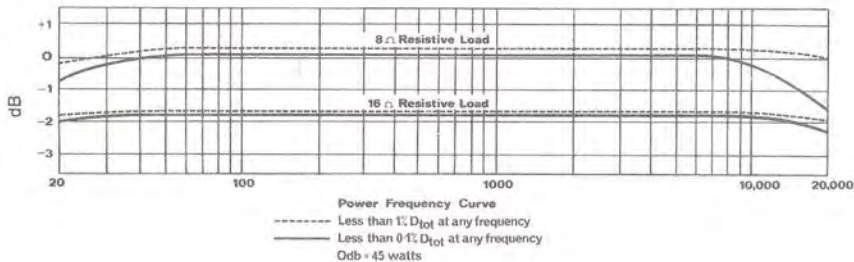
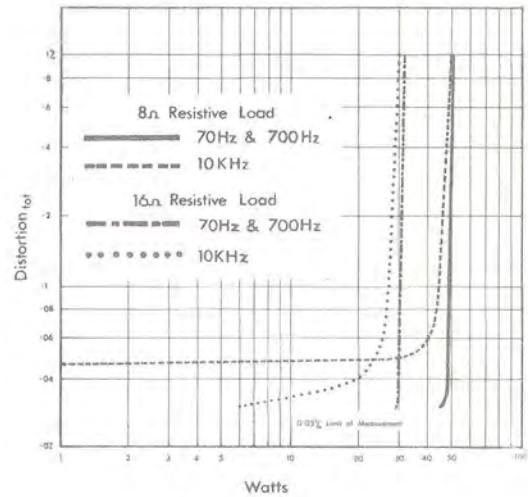
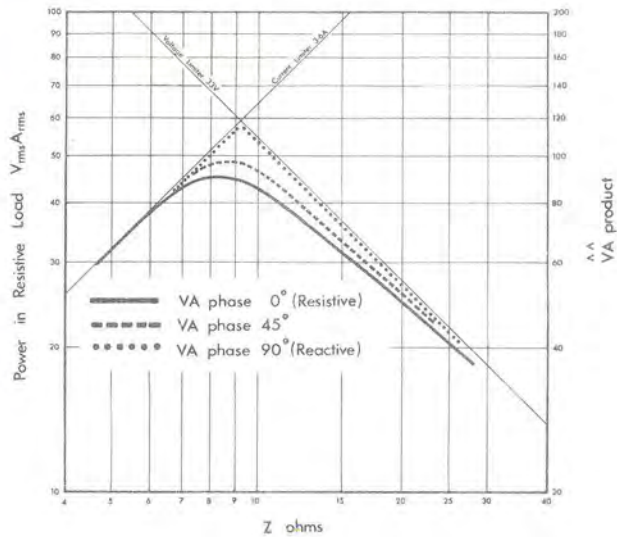

QUAD 303  
PERFORMANCE  
CURVES



## Guarantee

*This instrument is guaranteed against any defect in material or workmanship for a period of twelve calendar months from the date of purchase.*

*Within this period we undertake to supply replacements free of charge for any parts which may prove on examination to be defective provided that such defectiveness is not the result of misuse (including use with unsuitable ancillary equipment), accident or negligence, and further that the instrument was purchased at the proper retail price prevailing in the country of purchase.*

*Any set requiring service under this guarantee should be taken to the supplier through whom it was purchased, or, in case of difficulty, it should be carefully packed and consigned, carriage paid to the main distributor for the country of purchase quoting the date and place of purchase. It must not be sent to any other agent or distributor except by special arrangement.*

*This guarantee is valid only when these conditions are complied with and does not cover labour or carriage costs involved in any repair under the guarantee.*

*Note: No guarantee card is packed with the equipment.*

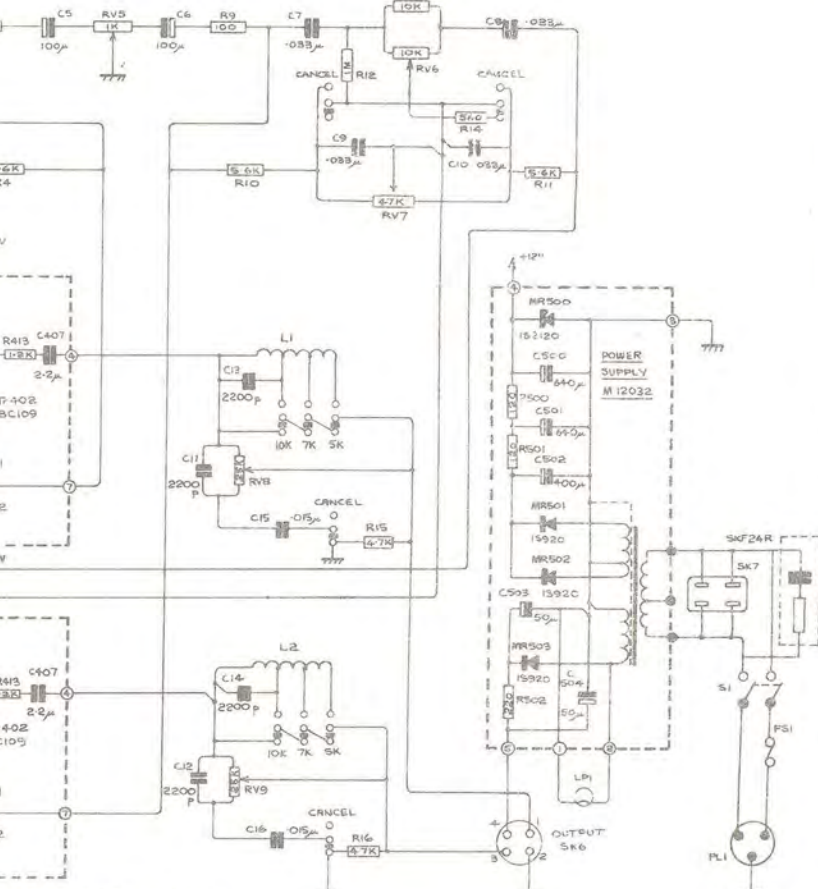
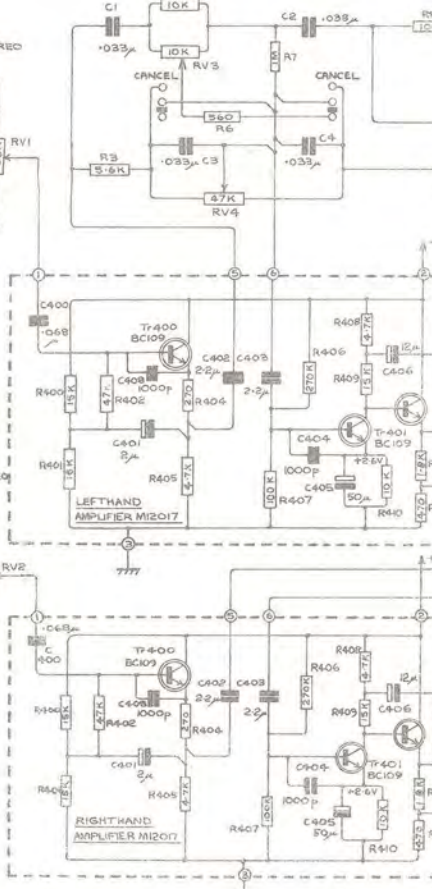
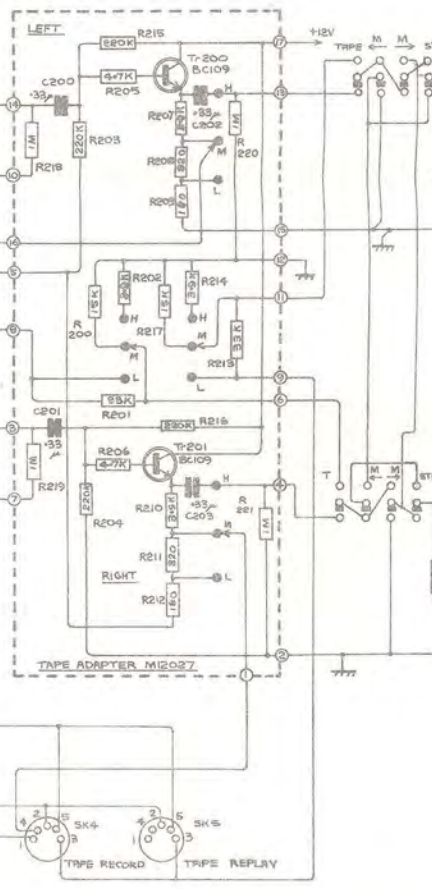
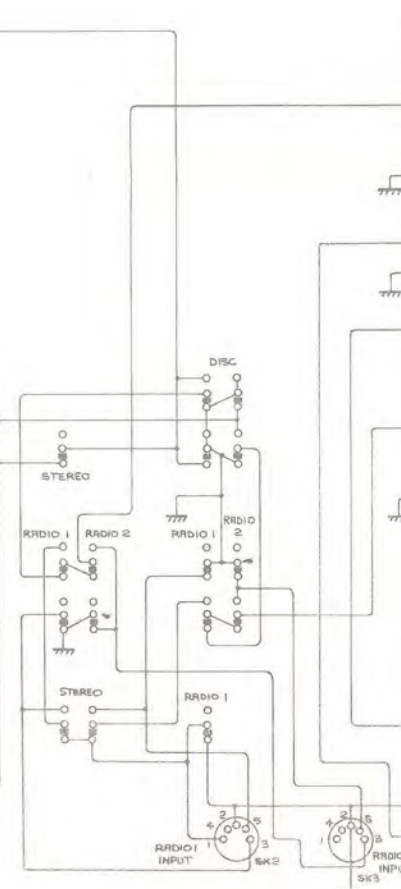
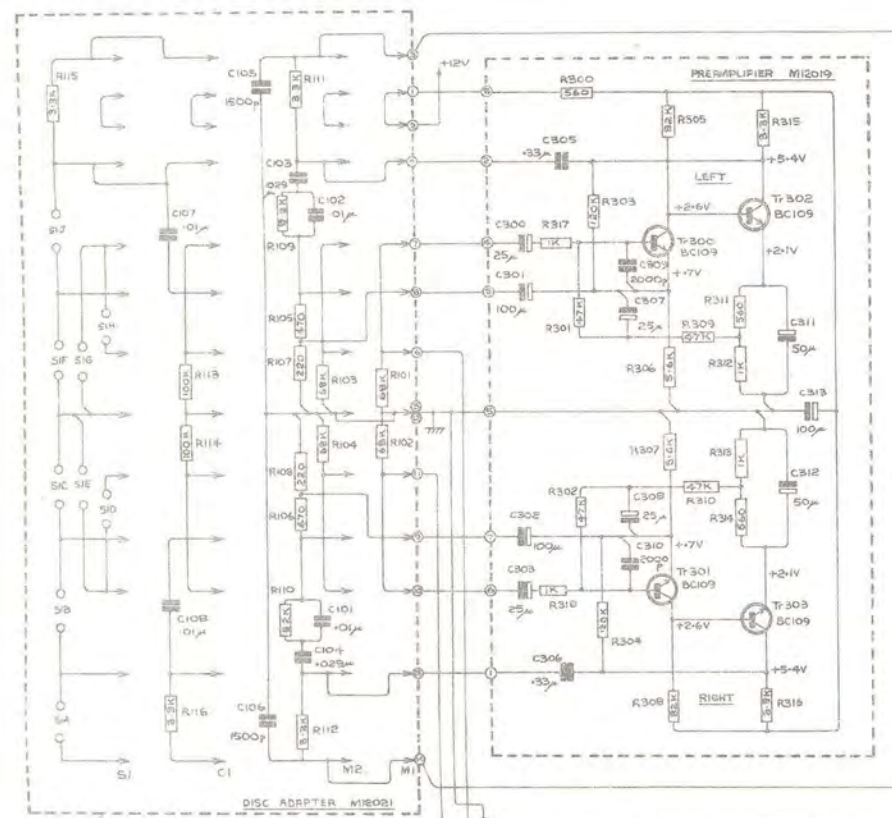
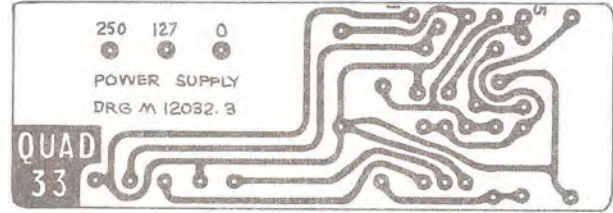
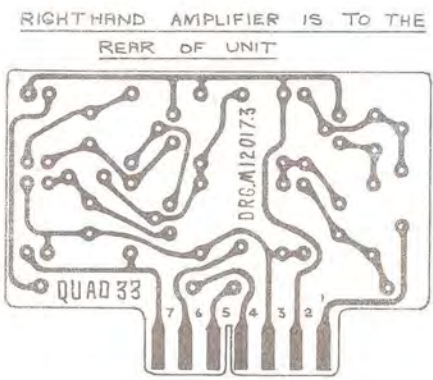
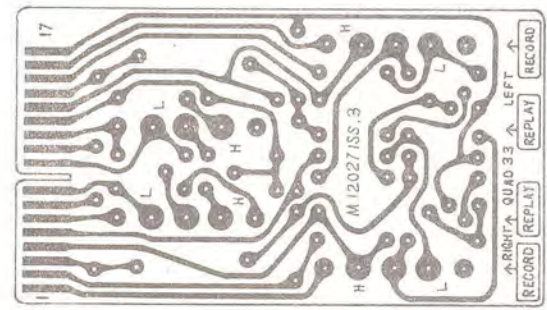
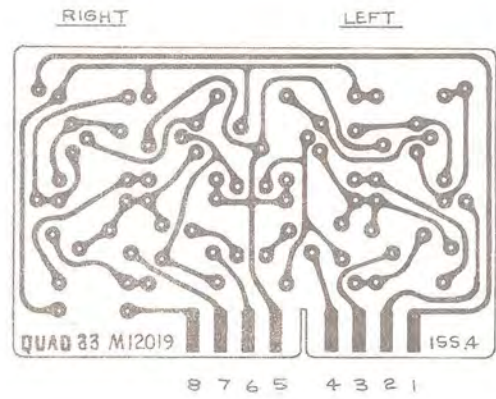
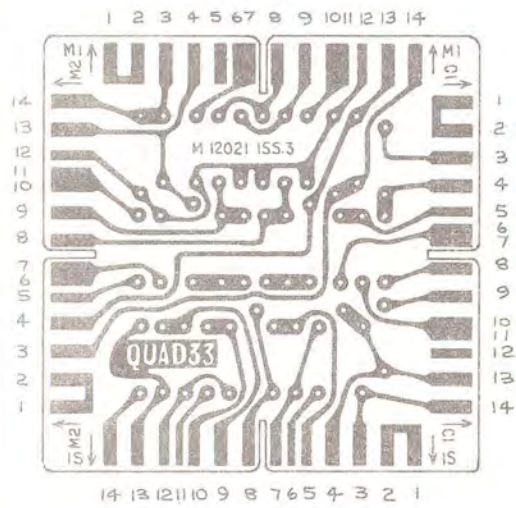

RESISTORS R105 TO R112 & CAPACITORS C101 TO C106 CHANGE CHANNELS IN M2 CONNECTION

ALL INPUT CONNECTIONS ARE PIN 2 - EARTH  
PIN 3 - LEFT CHANNEL  
PIN 5 - RIGHT CHANNEL

THE FRONT SECTION OF EACH DUAL CONTROL IS IN THE LEFT CHANNEL

VOLTAGES SHOWN ARE APPROXIMATE AND ALLOWANCE SHOULD BE MADE FOR LOADING EFFECTS OF A VOLTMETER

V EMITTER OF T-200, 201, 400, 402 = 5-6.5V

CIRCUIT CHANGES MAY BE MADE FROM TIME TO TIME WITHOUT NOTICE



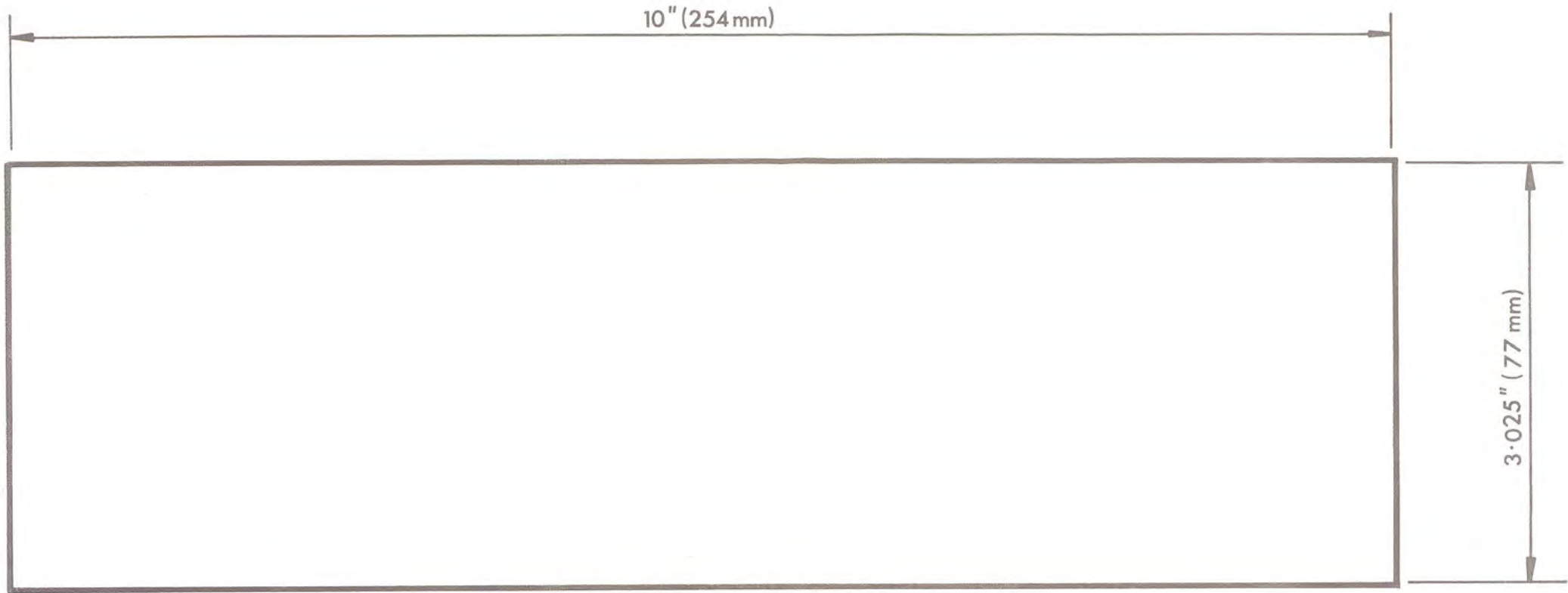

10" (254 mm)

3.025" (77 mm)

CUTOUT TEMPLATE FOR QUAD CONTROL UNIT & TUNER

