

606
POWER AMPLIFIER

INSTRUCTION BOOK

Q U A D

QUAD 606

Power Amplifier

INSTRUCTION BOOK

CONTENTS

	<i>Page Number</i>
Packing.....	2
Service.....	2
Guarantee.....	3
Cleaning.....	3
Description.....	4
Installation.....	5
Front view.....	6
Back view.....	7
AC Input.....	8
Fuses.....	8
Amplifier protection.....	10
Earthing (Grounding).....	10
Input connection.....	10
Loudspeaker connection.....	10
Loudspeaker protection.....	11
Quad electrostatic loudspeaker.....	11
Loudspeaker phasing.....	11
Headphones.....	11
Specification.....	12

QUAD ELECTROACOUSTICS LTD.,

HUNTINGDON.

Cambs.

PE18 7DB.

Telephone No.: Huntingdon (0480) 52561

Telex: 32348 QUAD G

Fax: (0480) 413403

Quad is a registered trade mark

Accessories Pack Contents

	Stock No.
1 AC Lead (I.E.C.)	QSPES1A
1 Signal Lead (Phono)	QP2P21A
2 Loudspeaker Output Plugs - Red	PP60912
2 Loudspeaker Output Plugs - Black	PP60920

Service

If servicing is required the power amplifier should be returned to the supplier, the distributor for the country of purchase or to Quad Electroacoustics Ltd. A brief note should be enclosed giving your name and address and the reason for returning it.

QUAD offers same-day service from Monday to Friday except for bank holidays. The map below shows where to find us. Please call 0480 52561 to make an appointment.

Circuit diagrams and service data for this Quad product are available from the manufacturer or distributor for a small charge.

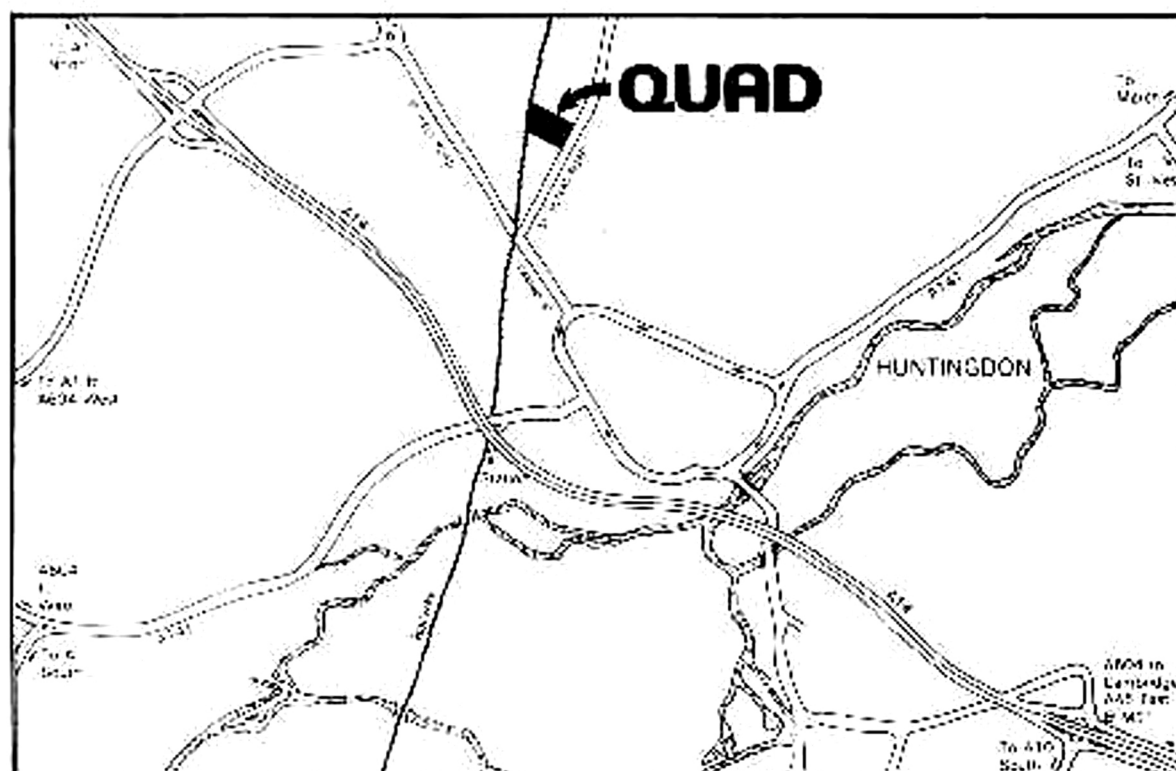

IMPORTANT

THE CARDBOARD CARTON AND EXPANDED POLYSTYRENE PACK SHOULD BE RETAINED IN CASE THE UNIT HAS TO BE RETURNED TO THE MANUFACTURER OR DISTRIBUTOR FOR SERVICE.

Guarantee

This amplifier is guaranteed against any defect in material and workmanship for a period of twelve months from the date of purchase.

Within this period we undertake to supply replacement parts free of charge provided that failure was not occasioned by misuse, accident or negligence. Freight costs are not covered unless by local agreement.

Within the U.K. the guarantee offered with this equipment does not limit the consumer's existing statutory rights. A separate guarantee card is not supplied with your Quad unit. Your guarantee begins on the day on which you take delivery.

Cleaning

The Nextel finish on the top and bottom castings of the Quad 606 is very hard wearing. It can be cleaned as follows:

- (a)** Dust and fingermarks can be removed by means of a soft brush, moist cloth or sponge. Removal is facilitated by using aqueous detergents, washing-up liquid or methylated spirit.
- (b)** Stains caused by mineral oils, lubricants, vegetable fats, can be removed with a cloth, sponge or brush together with methylated spirit or isopropyl alcohol.
- (c)** Stains caused by water-soluble agents such as jam, tea, coffee, fruit juice, etc. can be removed with a cloth, sponge or brush together with aqueous detergents, washing-up liquid, or a light scrubbing with a moist SCOTCHBRITE pad.

In all cases, a regular cleaning schedule will prevent the build-up of stains, which may, in time, prove difficult to remove.

Please note: The cleaning instructions are copied verbatim from the paint manufacturers' instructions and do not reflect the way in which we anticipate that you will use your Quad 606.

Description

The Quad 606 is a high power output two channel power amplifier primarily intended for use in high quality sound reproducing systems. The amplifier is usually used with a Quad control unit though other signal sources can readily be accommodated.

The amplifier uses a current dumping output circuit, a Quad invention which eliminates many of the problems associated with transistor amplifiers, and is covered by patents in several countries. In a current dumping amplifier there is in effect both a low powered very high quality amplifier and a high powered heavy duty amplifier. The low power amplifier controls the loudspeakers at all times, calling upon the high power section to provide most of the muscle. The small amplifier is so arranged – it carries an error signal – that provided the larger power transistors (the dumpers) get within the target area of the required output current it will fill in the remainder accurately and completely. The reproduced quality is solely dependent on the small amplifier which because of its low power can be made very good indeed.

Problems of crossover, crossover distortion, quiescent current adjustment, thermal tracking, transistor matching, all disappear. There are no internal adjustments or alignments and the choice of power transistor types is less restrictive.

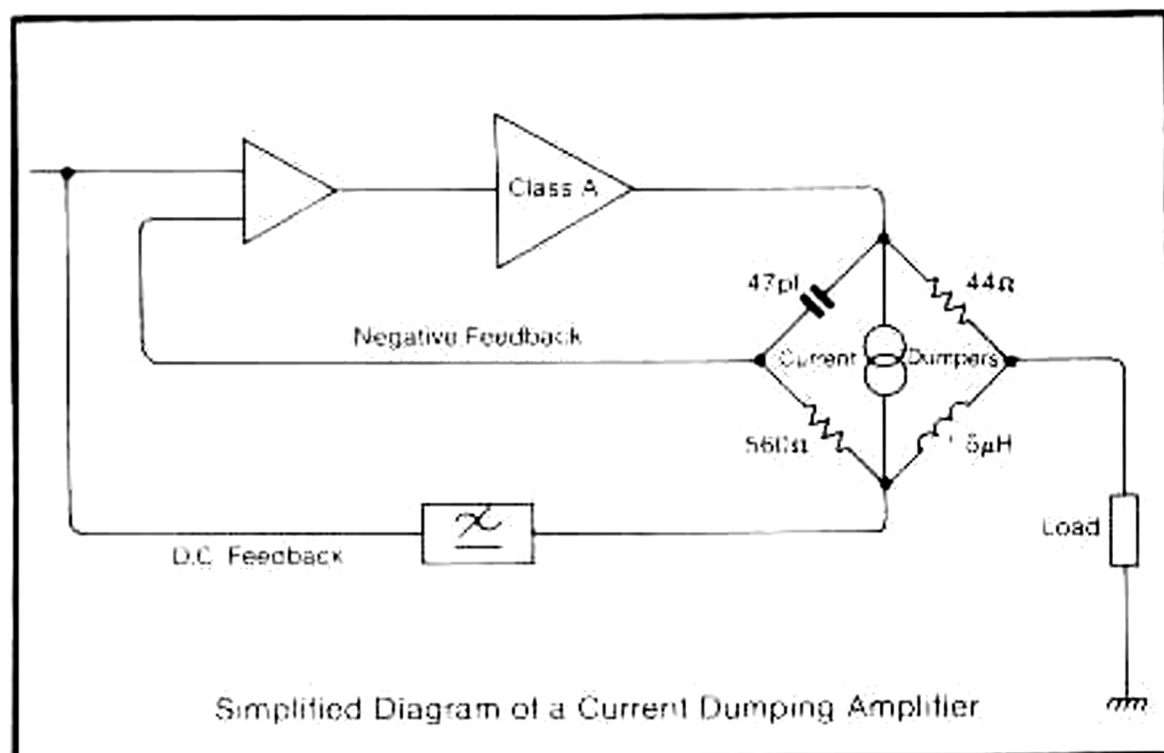

Installation

The Quad 606 carries no controls other than an on/off switch and may be mounted out of sight in a cabinet or other convenient location. However, since its dimensions correspond with those of the Quad 34, 44 and FM4 units they may be stacked vertically or stood side by side as required.

If used in close proximity to a pre-amplifier, pickup cartridge or other equipment susceptible to hum, it may be necessary to increase the spacing between them.

The amplifier will normally run warm, the actual temperature depending on the amount of work it is called upon to do. A resettable circuit breaker will automatically switch the amplifier off under conditions likely to cause damage due to gross overload, short-circuited output etc, but the fins of the heatsink should be kept clear of obstruction to permit adequate ventilation in normal use.

See Amplifier Protection – page 10.

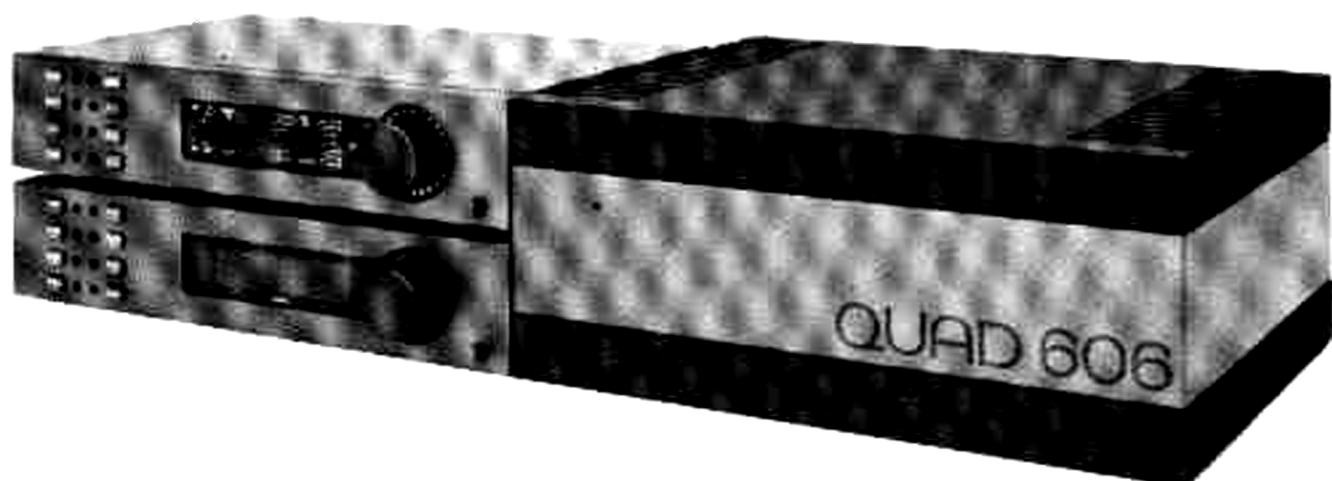

QUAD 606

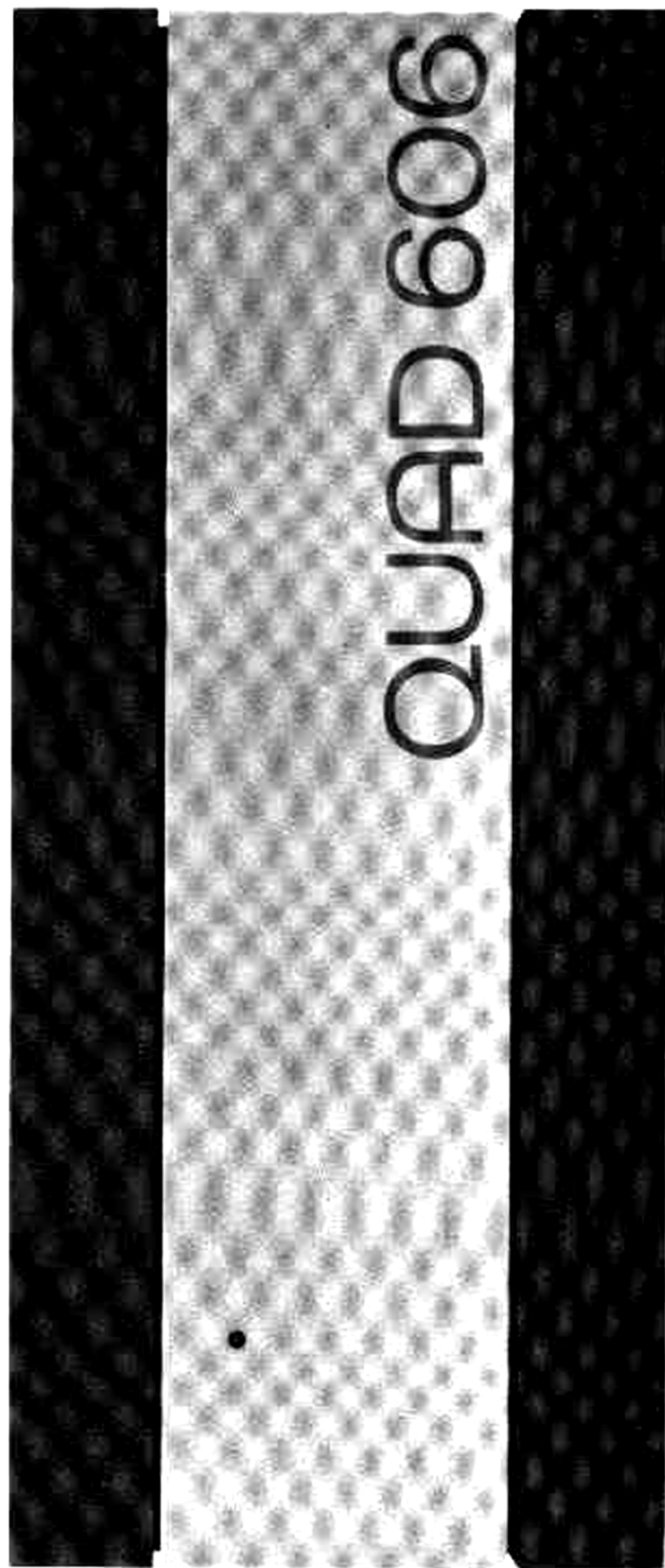

FRONT VIEW

QUAD 606

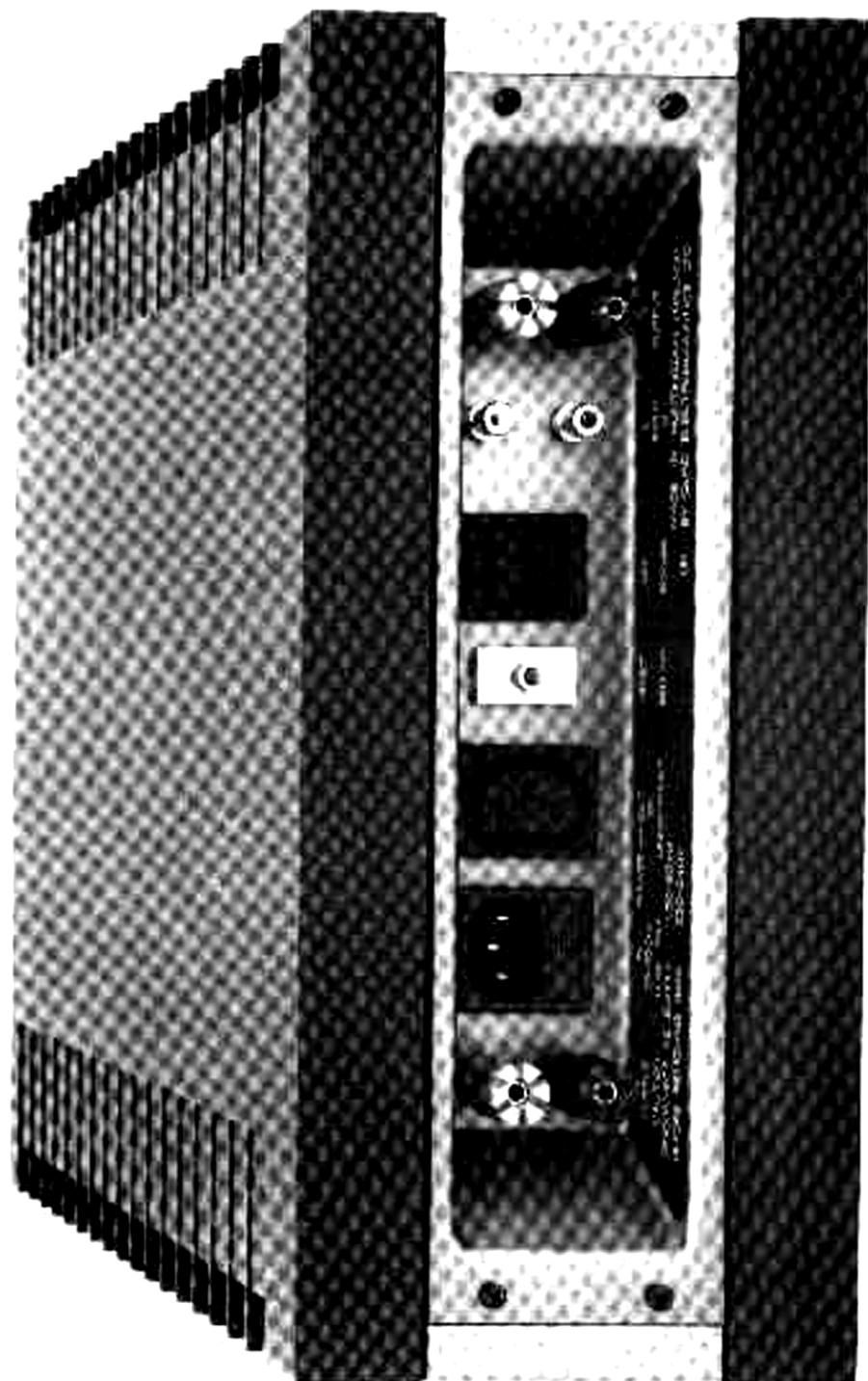

BACK VIEW

A.C. MAINS SUPPLY

This amplifier is designed to operate on one range of A.C. mains voltage only, 50 or 60 Hz, either 110/120 volts or 220/240 volts.

The designed operating voltage of the amplifier is clearly marked on the back.

BEFORE CONNECTING THE AMPLIFIER TO THE A.C. SUPPLY CHECK THAT THE VOLTAGE MARKED ON THE BACK OF THE AMPLIFIER CORRESPONDS WITH THAT OF THE A.C. SUPPLY.

The A.C. mains input is via a standard 3-pin Euro connector supplied with the amplifier which should be wired in accordance with the international code (see Fig. 1).

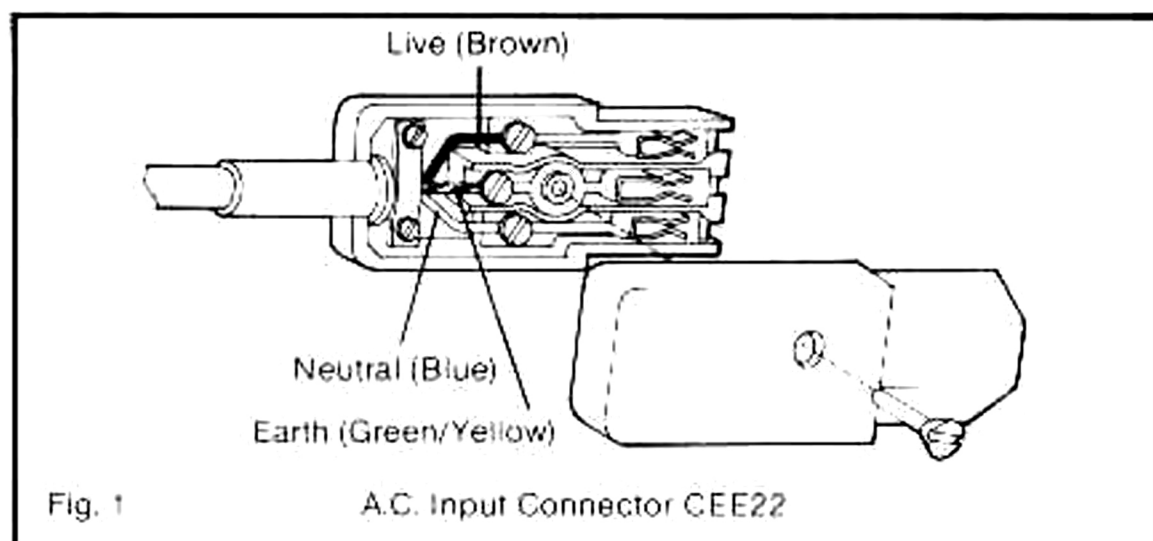

The A.C. supply will normally be drawn from the A.C. supply outlet on the rear of the Quad pre-amplifier. A suitable lead is supplied with the amplifier. The switch on the amplifier may be left permanently in the ON position, and both amplifier and pre-amplifier then switched on and off at the pre-amplifier.

A surge-resisting fuse (4 amp for 220/240V, 6.3 amp for 110/120V) housed in the mains input receptacle in the rear panel provides the usual protection. To obtain access to the fuse, unplug the mains supply and use a small screwdriver to lever open the drawer carrying the fuse. (see Fig. 2).

If a replacement fuse has to be fitted, make sure that it is of the correct type. The marking will be 4AT (6.3AT for 110v.)

In addition there are two 6.3 amp fuses in the secondary feed to the rectifier held in clips inside the amplifier. Their correct marking is 6.3AT.

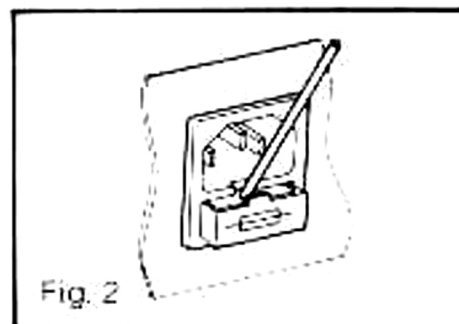

An unswitched A.C. outlet supplies appropriate additional equipment up to a maximum current of 4 amps. The shrouded plug supplied with the control unit may be used with this outlet and should be wired as shown in Fig. 3.

The indicator lamp is powered from the internal DC rail supply of one channel.

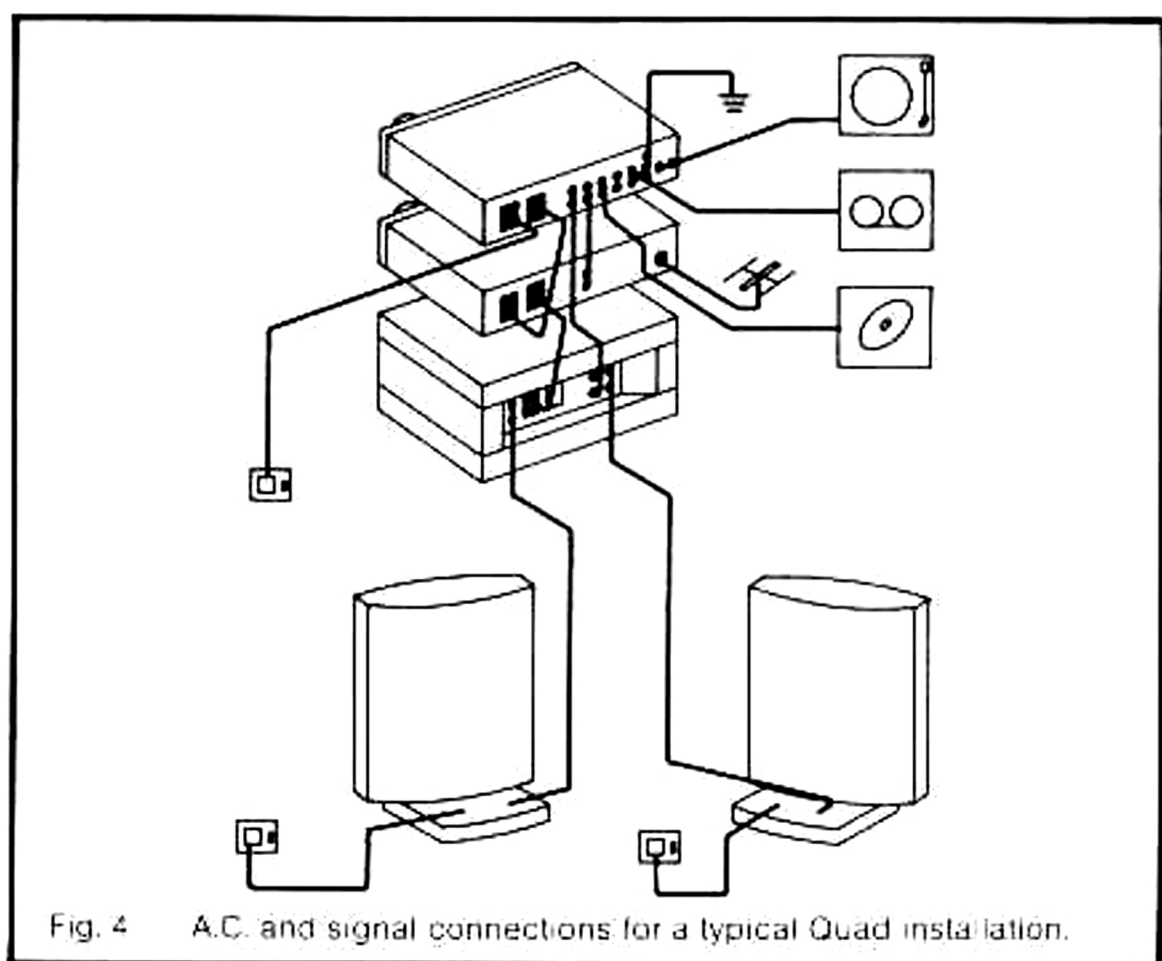
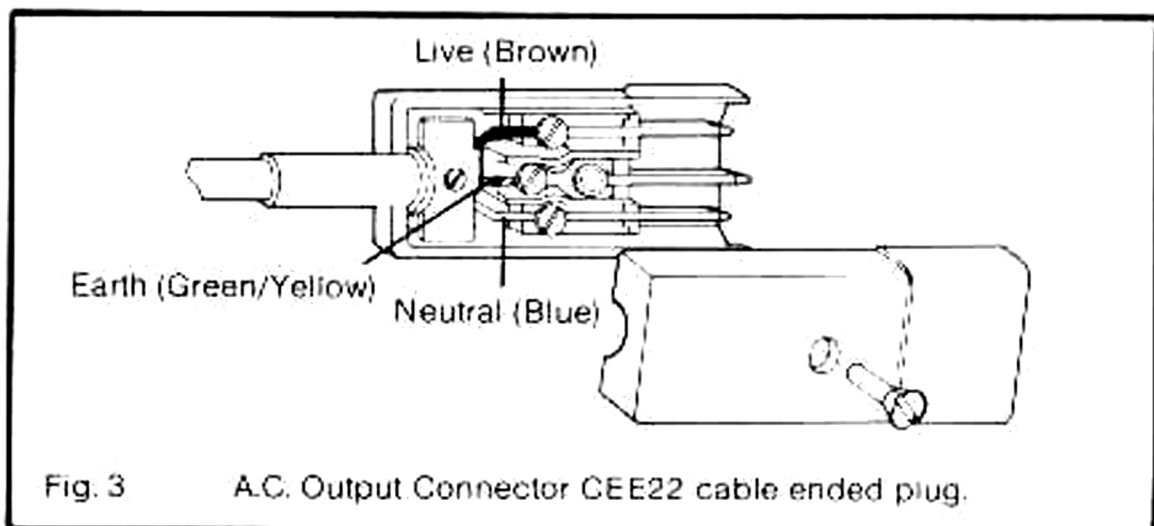

On/Off Switch

The Quad 606 is fitted with an on/off switch to comply with safety regulations in certain countries.

In normal practice it should be left on. The amplifier is then switched on and off from the control unit.

Amplifier Protection

The amplifier is protected by a resettable trip which interrupts the incoming AC supply if the amplifier is grossly overdriven for a period of time. To restore operation switch off the amplifier and press the red reset button on the back panel. The amplifier is thus fully protected against gross overload, short-circuited output etc. but not necessarily against seriously inadequate ventilation.

Earthing (Grounding)

A 3-core A.C. mains lead should be used to earth the amplifier whether its supply is taken direct from the wall socket or, more usually, the A.C. outlet of a Quad control unit or other similar source.

Input Connections

Signal input is via phono sockets, clearly marked L (left) and R (right).

If the amplifier is used with a Quad 33/34/44 control unit with a DIN output socket, you will need a 4-pin-DIN-to-2-phono-plugs lead. This may be obtained from QUAD, or your dealer by quoting part number QD4FP1A.

Loudspeaker Connections

The Quad 606 is fitted with 4mm sockets and binding posts. Red and black plugs are packed with the unit. The amplifier is unconditionally stable and may be used with any type of speaker cable. For optimum performance it is necessary to ensure that the impedance of the cable is small relative to the impedance of the load.

Each loudspeaker should be connected to its appropriate amplifier output so that the two pairs of wires are connected in the same way, to ensure that the speakers operate in phase. The output terminals are colour-coded to facilitate this.

Should there be any doubt, the phasing can be checked later experimentally. (See Page 11). Where one loudspeaker only is used for mono, either channel may be used and the terminals of the other channel left vacant. A dummy load resistor is not required. In cases where loudspeakers, such as the electrostatic loudspeaker, also require an energising supply, the instructions provided with the loudspeaker should be followed.

Each loudspeaker should be capable of handling the full output of the amplifier. The outputs of the 606 must not be connected either in series or in parallel to produce a single channel power amplifier.

Loudspeaker Protection

The loudspeaker manufacturer usually states a maximum recommended amplifier power for his loudspeaker, but as the maximum safe power for most loudspeakers is time and frequency dependent it is difficult to define precisely for a music signal. Some manufacturers will permit their loudspeakers to be used with amplifiers exceeding the quoted handling capacity provided certain precautions are observed. This can sometimes be advantageous in enabling short duration high level peaks to be handled without overload. The advice of the loudspeaker manufacturer or his agent should always be obtained before embarking on such a procedure.

Quad Electrostatic Loudspeaker

The Quad 606 is entirely compatible with the ESL-63 loudspeaker but should not be used with the earlier model which could easily be damaged.

Loudspeaker Phasing

If there is any doubt about the way in which the loudspeakers are connected (see Page 10), their phasing may now be checked by playing a mono disc over both channels: when the sound should appear to emanate from a point midway between them: if this is indefinite the connections to either of the loudspeakers, but not both, should be reversed. Correctly connected the loudspeakers will give a definite centre sound source accompanied by a more full-bodied sound in the tenor and bass registers.

Headphones

Headphones will normally be used in place of loudspeakers and there are a number of suitable switch units on the market designed to enable the loudspeakers to be switched off when the headphones are plugged in. Most of these units also make provision for simple attenuator circuits to be incorporated where the sensitivity of the headphones requires this to permit operation at normal settings of the pre-amplifier volume control.

Electrostatic or other types requiring a high level input should be connected in accordance with their manufacturers' instructions.

All return leads should be taken direct to the black output sockets and not via earth or to chassis.

Specification

Measurements apply to either channel. All measurements made at 230V A.C.

Power Output: see graph.

Distortion: Continuous sine wave into 8 ohm resistive load
20Hz any level up to 130 watts < 0.01% Dtot
1kHz any level up to 130 watts < 0.01% Dtot
20kHz any level up to 130 watts < 0.03% Dtot

Output Internal

Impedance & Offset: 1.5µH in series with 0.05 ohm. Offset typically 7mV

Frequency

Response: Ref 1kHz
0.25dB at 20Hz and 20kHz
-1.0dB at 13Hz and 40kHz

Power Response: Ref 1kHz
0.25dB at 20Hz and 20kHz

Signal Input Level: 0.5 volts for 140 watts into 8 ohms

Signal Input

Overload: Instantaneous recovery up to +5dB overload.

Crosstalk: Input loaded at 1k ohm
-100dB at 100Hz
-85dB at 1kHz
-65dB at 10kHz

Hum and Noise: (15.7kHz measurement bandwidth)
Unweighted -105dB ref. 140 watts

Stability: Unconditionally stable with any load and any signal

AC Input: 110-120V or 220-240V, 30-850 watts, depending on signal level.

Weight: 12.0 kgs

Dimensions: 321mm wide, 140mm high, 238mm deep.

