

INSTRUCTION BOOK

**QUAD 22 CONTROL UNIT**  
**AND**  
**QUAD II POWER AMPLIFIER**



# QUAD 22 CONTROL UNIT

## QUAD II POWER AMPLIFIER

### INSTALLATION AND OPERATION

WHEN installing this amplifier it should be borne in mind that the standard of performance of the complete equipment is limited by that of the poorest component part. Thus the gramophone motor and pickup, loudspeaker, etc., should all receive careful consideration if full advantage is to be taken of the capabilities of the amplifier.

## INSTALLATION

The QUAD 22 Control Unit may be used with a single QUAD II Power Amplifier for single channel installation, or with two QUAD II Power Amplifiers to provide single channel and stereo reproduction.

The Power Amplifiers contain no operating controls, so they may be mounted out of sight, usually in the bottom of the cabinet or other housing for the complete equipment.

Adequate ventilation should be provided. If the available space is large, ventilation may be provided by a perforated back or by openings near the bottom and top of the back, making sure that these openings are not blocked by placing the cabinet against a wall. When a compact installation is required considerable care is needed in ventilation design to make use of "chimney" effects.

Problems of installation will be eased if the power amplifiers are at least 2 feet from gramophone pickups, pickup transformers and tape heads.

*Page Two*

The fuse, fuseholder cap and voltage adjusting screw are removed before packing to avoid transit damage and should be re-inserted upon installation.

Two fixing screws are provided with each power amplifier so that it may be fastened in position.

The Control Unit may be mounted in a cabinet panel of any thickness up to  $\frac{3}{4}$ " (20mm.) in a position decided by ease of handling and aesthetic considerations. It may be horizontal, vertical or in any other position. It is neither susceptible to, nor causes interference in associated equipment.

A 10" x 3 1/16" (254 x 78mm.) opening with  $\frac{1}{4}$ " (6mm.) radius corners should be cut in the panel as shown in the template contained in the rear of this booklet.

Remove the two screws from the rear of the cover and slide the cover off.

Insert control unit, leads first, into the cut-out from the front. The lugs on the rear of the control unit front panel should locate inside the cut-out.

Replace the cover from the rear, making sure that the leads are not trapped. Insert the two screws and tighten until the control unit is just held in position, then give one additional turn to lock securely.

### Loudspeaker Connections

The proper placing of loudspeakers is extremely important and will inevitably entail experimentation. A separate section is devoted to this subject. Initially, however, an approximate position should be chosen for the speakers and since one of the services available with the control unit is to provide single channel on one loudspeaker, it is necessary to decide which of the loudspeakers is to be operative on this service. In order to comply with a colour coding used throughout the equipment, the single channel speaker should now be designated "Yellow" and the other speaker designated "Blue."

The two loudspeakers should now each be connected to one of the two power amplifiers making sure that the two pairs of wires are both connected in the same way (correctly phased). For example if the top terminal of

one amplifier is connected to the right hand terminal of one loudspeaker, then the other loudspeaker and amplifier should be similarly wired. Should there be any doubt or the loudspeakers dissimilar, this point may be ignored at this stage and subsequently checked and corrected if necessary when the equipment is operating.

The loudspeakers should have a nominal impedance of 15 ohms (12—20 ohms). Provision is made, however, for connection to 4—8 ohm loudspeakers by removing the base plate of the power amplifiers and removing the link between tags R and S on the output transformer, and linking instead tags Q to R and S to T.

When the loudspeaker leads are reasonably short, thin flex may be used, but if longer runs are employed then the cable should be sufficiently thick for its resistance not to exceed 10% of the loudspeaker impedance.

The two combination cables from the control unit should now be plugged in to the power amplifiers, the cable coloured yellow being connected to the power amplifier feeding the "yellow" speaker and the cable coloured blue to the amplifier feeding the "blue" speaker. When one power amplifier only is used it must be connected to the yellow cable from the control unit, the blue cable being left unconnected.

## Pickup

Normally a single stereo pickup, with or without interchangeable heads, will be used to play both stereo and mono discs, and the appropriate pickup adaptor is then identified by a single letter, the pickup being connected to the yellow and blue inputs. The black input is not used.

If, however, a separate pickup arm is used to play mono discs (the stereo pickup, if one is fitted, then being used to play stereo discs only) the adaptor is identified by two letters, and the stereo pickup connected to the yellow and blue inputs with the mono pickup to the black input.

A list is enclosed showing the appropriate units for various pickup cartridges and the methods of connecting different types of arm are shown in Fig. 1 on page 10.

Each control unit is supplied with a Pickup Adaptor, but should this be unsuitable for the pickups in use it may be exchanged free of charge within the guarantee period of 12 months either through the dealer from whom the amplifier was purchased, or in the case of difficulty, through the main distributor for that country (in the U.K. the Acoustical Manufacturing Co. Ltd.). A box in which to return the unit and a special double label

are provided to facilitate exchange by post where necessary.

## Radio

Two radio inputs may be connected monaurally to Radio 1 (yellow) and Radio 2 (black). A stereo channel may be accommodated on Radio 1 by using inputs Radio 1 (yellow and blue). For stereo any of three arrangements is possible, depending upon the broadcast system in use. Connections for these are shown in fig. 2, but where power supply requirements of a multiplex decoder unit differ from the arrangement shown the instructions supplied with the decoder should be followed.

The HT supplies at the three sockets become alive only when the appropriate service is selected by the push buttons. The total currents which may be drawn are as follows:

L.T. 6.3 Volts Yellow & Black Blue	3 Amps total 3 Amps
H.T. 330 Volts Yellow, Black & Blue	35mA each

The screen of the audio lead carries the H.T. negative return.

## Tape

Two inputs and two outputs are provided for connections to a tape machine. The yellow sockets are operative for monaural requirements and the yellow and blue sockets for stereo.

When connecting a recorder which includes its own record and replay amplifiers, the Tape N adaptor should be used. The equalised replay output(s) of the recorder should be fed into the TAPE socket(s) and the maximum signal level should lie between 0.1 and 0.5 volts. A load of 100,000 ohms is imposed across the recorder output.

The TO sockets (for recording) provide a *peak* level of approximately 0.25 Volt unaffected by bass, treble and filter controls. The input resistance of the tape recorder should not be less than 500,000 ohms and the capacity including the coupling cable should not exceed 200pF.

If tape replay is required direct from the replay head a Tape H1 (for European tapes) or Tape H2 (for American tapes) adaptor should be used. For high impedance heads connection is made direct to the TAPE socket(s). For low impedance heads connection is made via the head manufacturer's coupling transformer to the TAPE socket(s), the lead between the transformer and the sockets being kept as short as possible.

## Microphone

A microphone may be connected to the MIC input (black), this input being monaural only. The sensitivity is 1.5 mV rms at 100,000 ohms. Facilities for stereo microphones may be obtained by replacing the Tape N adaptor by a Mic N adaptor and feeding a twin microphone to the TAPE inputs (yellow and blue). Sensitivity is 1.5 mV rms at 100,000 ohms.

## Mains Connections

An efficient connection to earth should be provided and this should be connected to the "E" terminal on the back of the control unit.

Before connecting the mains, ensure that the voltage adjusting screws in the power amplifiers are correctly set to the voltage of the mains supply. AC mains may now be connected to the rear of the control unit by means of the 2 pin socket provided.

## Installation Adjustments

All the services required should now become available by pressing the appropriate buttons.

If it was not possible to phase the loudspeakers correctly during installation (see page three) this should now be carried out. A programme should be reproduced using the 2 MON service and the balance control adjusted to give approximately equal volume from the two loudspeakers. Listening at an equal distance from the two loudspeakers, the sound should appear to emanate from a point midway between them. If this is indefinite, the connections to one of the loudspeakers (either) should be reversed. The correct connection is that which gives a definite centre sound source and this will also be accompanied by a fuller sound in the tenor and bass registers. The effect may be exaggerated and the test therefore made easier if the loudspeakers are placed closer together.

The next adjustment is that of balance. This should be carried out in two stages :—

- (a) Select the two buttons marked Stereo and Disc. Play a monaural record with the stereo pickup and adjust the balance control until the sound appears midway between the loudspeakers. Note the setting required
- (b) If a multiplex radio and stereo tape machine are installed, they should now be similarly balanced using their own pre-set controls and leaving the

QUAD 22 balance control as already set under (a) above.

The balance control will now operate on all programmes but should require no attention for day to day listening. The only exceptions to this are :

- (1) If FM/AM stereo is used, or
- (2) If a misbalanced (and therefore faulty) record is to be played.

The balance control may require adjustment if the loudspeaker position or the environment is changed.

### Loudspeaker Position

The standard of reproduction obtained from any loudspeaker is influenced by both its position in the room and its position in relation to the listening area. The optimum position can only be found by experiment and this cannot be carried out quickly or in a perfunctory manner, if long term non-fatiguing listening is to be obtained.

With the advent of an additional speaker for stereo the difficulties are enormously increased. It is a fact that the standard of reproduction in many homes, both single channel and stereo, is significantly below that which could be obtained if sufficient attention had been paid to loudspeaker positioning.

It has been broadly stated that for stereo the two loudspeakers should be 6ft. to 8ft. apart with the listener at a similar distance from each.

Clearly, when more than one person is listening they cannot both occupy the same position and all listening tests should aim at obtaining good stereo over a reasonable area.

This can usually be achieved over an area immediately behind the listening point already defined, with a width equal to the distance between speakers and with a similar depth.

Outside this area the overall quality should be satisfactory although the perspective may be degraded.

The measurement of 6ft. — 8 ft. is based on a small room. With a larger room the scale may be increased accordingly.

The quality of the results obtained will depend upon the following :

single channel :—

- (a) The position of the loudspeakers with respect to the room boundaries (and sometimes floor joists).
- (b) The direction of loudspeaker axis.
- (c) The position of large pieces of furniture.

With stereo the following may be added :—

- (d) The distance apart.
- (e) The point of intersection of the loudspeaker axes.
- (f) The relation of the base line (an imaginary straight line joining the two speakers) to the room boundaries.
- (g) The position of the listeners.

This list is formidable. The instructions supplied with the loudspeaker may resolve some of the variables, the rest must be solved by experiment. Few people can successfully complete these experiments at a single session and it is strongly recommended that the following procedure be adopted.

The single channel loudspeaker should be tried in the various room positions which appear physically possible, in order to ascertain which positions are likely to be worth further investigation.

The loudspeaker should now be used in each of these positions for normal day to day listening. Normal attention should be given to the programme itself *with no conscious concentration on the quality*. In this way the optimum position for most satisfactory listening will become apparent.

A similar approach should be applied to stereo with the object of arriving at a position for the two speakers which is compatible with all listening requirements.



## OPERATION

Once the equipment has been properly installed, operation becomes simple and straightforward.

The equipment is switched on by rotating the volume control clockwise from the OFF position. The QUAD insert should now be illuminated.

The programme and the type of service required should now be selected by means of the push buttons.

The input required is selected by depressing one or a combination of the four right-hand buttons. The service required—i.e., stereo, single channel on one loudspeaker or single channel on two loudspeakers—is selected by means of the remaining two buttons on the left-hand side.

With the stereo button depressed, choice of three stereo inputs becomes available selected by the appropriate button—Radio—Tape—Gram.

With the MON (monaural) button depressed, the following single channel inputs become available—Radio 1 — Radio 2 — Tape — Microphone—Gramophone. In addition there is a choice of four playback characteristics for gramophone, obtained by pressing a combination of buttons in accordance with the chart enclosed in

this booklet. By depressing both left-hand buttons, all the monaural facilities are available as already described but reproduced now on both loudspeakers through both power amplifiers. When two adjacent buttons have to be pressed it will be found more convenient to use one finger only, applying pressure over the gap between the buttons.

The filter should initially be set to the 7K position with the filter slope and the bass and treble controls at "level."

Musical balance of treble and bass is adjusted by the treble and bass controls. With a high grade loudspeaker only very slight deviation from level should ever be required.

Small deviations of the bass control will affect very low notes only. Greater deviations affect not only the very low notes to a greater extent but also the higher bass notes. The treble control affects brilliance.

The filters affect the extreme harmonic range only and do not interfere with musical brilliance. Their purpose is to enable the maximum content of the programme to be reproduced with the minimum distortion.

With most types of recording the distortion inherent in the recording system itself is greatest at very high frequencies. The wider the loudspeaker range the more audible this is liable to become. It may be removed or mitigated by rotating the filter slope control anti-clockwise from the level position. As the control is rotated, the quality and "cleanliness" of the reproduction will improve. There will, however, be a point at which further rotation degrades the sound due to intrusion into the useful harmonic range.

The 7K is the most useful switch position for modern recordings. The 5K switch position transposes the filter operation to a lower frequency for use with older recordings. Conversely the 10K position transposes the filter to higher frequencies and here it is useful on high quality transmissions where it may be used for the subtle correction of imperfections associated with microphones.

A cancel position is fitted to the filter switch. In this position, the bass, treble and filters are all bypassed to give a level response. This position is a reference by which the effects of the settings of the other controls may be judged without upsetting the position of these controls.

The control situated immediately beneath the volume

control adjusts the relative volume from the two loudspeakers. It should require no attention during normal operation, but see page six.

The whole of the operation of the equipment may be summarised :

Use bass and treble controls to give best results on all types of programme. This helps compensate for loudspeaker peculiarities, personal preference, etc.

Select programme and type of service.

Adjust volume to suitable level.

Adjust filter as required. (7K switch position may be regarded as normal).

Alter bass and treble only if it is required to alter the musical balance.

With a magnetic tape recorder properly connected to the unit, it is possible to record any programme selected by the control unit push buttons. The correct level must be set at the tape machine. The recording will then be correctly carried out independently of the setting of the QUAD 22 controls. These may therefore be adjusted as desired to suit listening conditions while the recording is in progress.

STEREO P.U. WITH COMMON CONNECTION

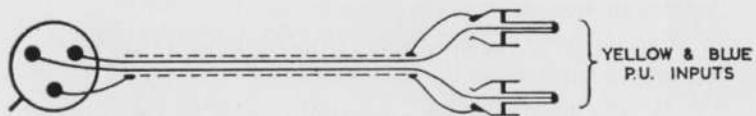

STEREO P.U. WITH ISOLATED OUTPUTS



MONAURAL P.U. IF REQUIRED SEPARATELY

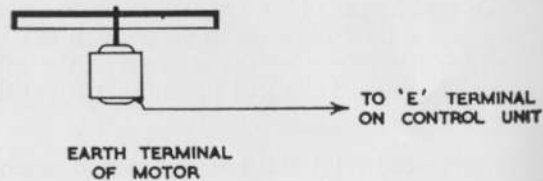
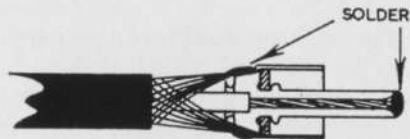
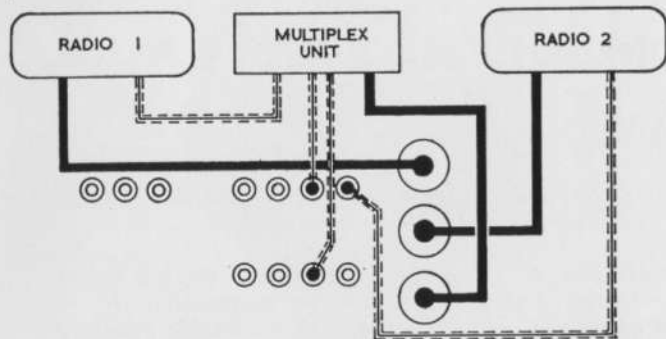

FIG. 1

# RADIO CONNECTIONS

(A) MULTIPLEX



(B) SEPARATE CHANNELS

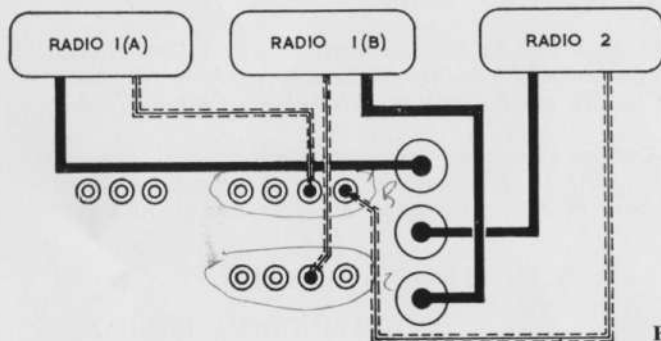

(C) RADIO 2 TO PAIR WITH RADIO 1

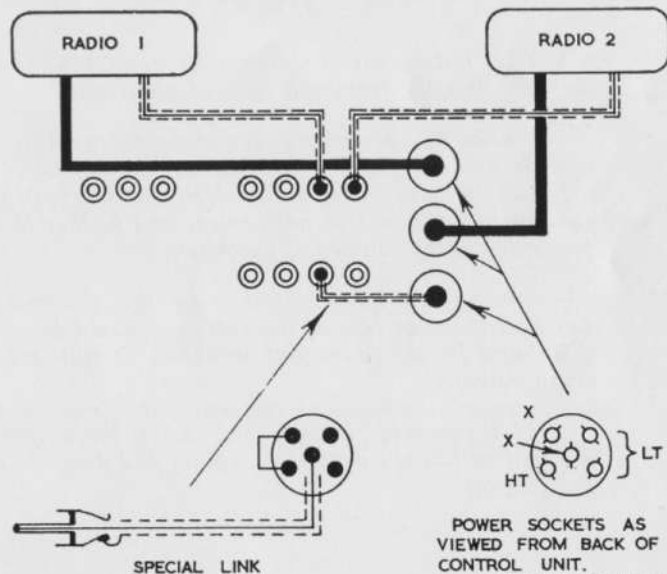

FIG. 2

POWER SOCKETS AS VIEWED FROM BACK OF CONTROL UNIT.  
X — INTERNAL CONNECTION

## Guarantee

---

*This instrument is guaranteed against any defect in material or workmanship for a period of twelve calendar months from the date of purchase.*

*Within this period we undertake to supply replacements free of charge for any parts excepting valves (which are covered by the makers' guarantee of three months) which may prove on examination to be defective, provided that such defectiveness is not the result of misuse (including use with unsuitable ancillary equipment), accident or negligence, and further that the instrument was purchased at the proper consumer price prevailing in the country of purchase.*

*Any set requiring service under this guarantee should be taken to the supplier through whom it was purchased, or, in case of difficulty, it should be carefully packed and consigned, carriage paid, to the main distributor for the country of purchase. It must not be sent to any other agent or distributor except by special arrangement.*

*This guarantee is valid only when the enclosed card is properly filled in and returned for registration as directed within ten days of purchase, and does not cover labour or carriage costs involved in any repair under the guarantee.*

ACOUSTICAL MFG. CO. LTD.,

HUNTINGDON, ENGLAND.

# QUAD 22 CONTROL UNIT

## QUAD II POWER AMPLIFIER

### MAINTENANCE

It is important that similar components are used for replacement purposes, especially as to tolerance, rating, and, in the case of condensers, construction.

## QUAD 22 CONTROL UNIT COMPONENTS LIST

Component Reference	Value	Tolerance	Makers Reference	Stock No.	Layout Photograph
R.1	100K	± 10%	Dubilier BTS	200/A	A
R.2	100K	± 10%	Dubilier BTS	200/A	B
R.3	100K	± 10%	Dubilier BTS	200/A	A
R.4	4.7K	± 10%	Dubilier BTS	240/F	A
R.5	47K	± 10%	Dubilier BTS	208/F	A
R.6	15K	± 10%	Dubilier BTS	224/C	A
R.7	10K	± 10%	Dubilier BTS	230/E	A
R.8	100K	± 10%	Dubilier BTS	200/A	A
R.9	82K	± 10%	Dubilier BTS	203/B	A
R.10	4.7K	± 10%	Dubilier BTS	240/F	C
R.11	100K	± 10%	Dubilier BTS	200/A	C
R.12	1.5M	± 10%	Dubilier BTS	160/A	A
R.13	1.5M	± 10%	Dubilier BTS	160/A	A
R.14	2.7K	± 10%	Dubilier BTS	248/D	A
R.15	2.7K	± 10%	Dubilier BTS	248/D	A
R.16	270K	± 5%	Painton 73	185/C	A
R.17	270K	± 5%	Painton 73	185/C	A
R.18	1.5M	± 10%	Morganite S	160/E	A
R.19	1.5M	± 10%	Morganite S	160/E	A
R.20	47K	± 10%	Dubilier BTS	208/F	A
R.21	4.7K	± 5%	Painton 72	240/G	A
R.22	4.7K	± 5%	Painton 72	240/G	A

Component Reference	Value	Tolerance	Makers Reference	Stock No.	Layout Photograph
R.23	470K	± 5%	Painton 73	176/F	A
R.24	470K	± 5%	Painton 73	176/F	A
R.25	27K	± 10%	Dubilier BTS	210/D	A
R.26	1.5M	± 10%	Dubilier BTS	160/A	A
R.27	1.5M	± 10%	Dubilier BTS	160/A	A
R.28	1K	± 10%	Dubilier BTS	258/E	A
R.29	1K	± 10%	Dubilier BTS	258/E	A
R.30	47K	± 10%	Dubilier BTS	208/F	A
R.31	47K	± 10%	Dubilier BTS	208/F	A
R.32	15K	± 10%	Dubilier BTS	224/C	A
R.33	39K	± 10%	Dubilier BTS	208/M	B
R.34	68K	± 10%	Dubilier BTS	205/B	B
R.35	39K	± 10%	Dubilier BTS	208/M	B
R.36	68K	± 10%	Dubilier BTS	205/B	B
R.37	12K	± 10%	Dubilier BTS	228/D	B
R.38	12K	± 10%	Dubilier BTS	228/D	B
R.39	330K	± 10%	Dubilier BTS	179/B	B
R.40	330K	± 10%	Dubilier BTS	179/B	B
R.41	27K	± 10%	Dubilier BTS	210/D	B
R.42	68K	± 10%	Dubilier BTS	205/B	B
R.43	27K	± 10%	Dubilier BTS	210/D	B
R.44	68K	± 10%	Dubilier BTS	205/B	B
R.45	220	—	Dubilier SFK38R with R46 C32 and C33	441/C	C
R.46	220	—	See R45		C
R.V.1A.	500K Log		Acoustical Drg. No. A 11350 Iss. 2 with RV1B, RV3 and S4A-B	415/B	A
R.V.1B.	500K Log		Ganged and Matched with RV1A		A



Component Reference	Value	Tolerance	Makers Reference	Stock No.	Layout Photograph
R.V.2A.	500K Lin		Acoustical Drg. No. A11351 Iss. 1 with RV2B	410/J	B
R.V.2B.	500K Lin		Ganged and Matched with RV2A		B
R.V.3	12.5K		With RV1A		A
R.V.4A.	250K Log		Acoustical Drg. No. A11351 Iss. 1 with RV4B	405/A	B
R.V.4B.	250K Log		Ganged and Matched with RV4A		B
R.V.5A.	100K Lin		Acoustical Drg. No. A11351 Iss. 1 with RV5B	400/E	B
R.V.5B.	100K Lin		Ganged and Matched with RV5A		B
C.1	5000p	± 10%	Dubilier 400	510/C	C
C.2	5000p	± 10%	Dubilier 400	510/C	A
C.3	.1μ	—	Hunts AM 108	495/A	A
C.4	.1μ	—	Hunts AM 108	495/A	A
C.5	25μ	—	Hunts MEW7T	465/E	A
C.6	25μ	—	Hunts MEW7T	465/E	A
C.7	16μ	—	Hunts KDN485 with C12 and C15	469/C	A
C.8	.5μ	—	Hunts AM104	490/D	A
C.9	.5μ	—	Hunts AM104	490/D	A
C.10	25μ	—	Hunts MEW7T	465/E	A
C.11	25μ	—	Hunts MEW7T	465/E	A
C.12	16μ	—	See C7	—	A
C.13	820p	± 10%	Suflex HS15/L	519/A	A
C.14	820p	± 10%	Suflex HS15/L	519/A	A
C.15	16μ	—	See C7	—	A
C.16	.1μ	—	Hunts AM108	495/A	C
C.17	.1μ	—	Hunts AM108	495/A	C
C.18	5600p	± 10%	Dubilier 400	509/A	B
C.19	5600p	± 10%	Dubilier 400	509/A	B
C.20	5600p	± 10%	Dubilier 400	509/A	B

Component Reference	Value	Tolerance	Makers Reference	Stock No.	Layout Photograph
C.21	5600p	± 10%	Dubilier 400	509/A	B
C.22	4000p	± 10%	Dubilier 400	513/C	B
C.23	4000p	± 10%	Dubilier 400	513/C	B
C.24	220p	± 10%	Sufflex HS12L	526/A	B
C.25	220p	± 10%	Sufflex HS12L	526/A	B
C.26	220p	± 10%	Sufflex HS12L	526/A	B
C.27	220p	± 10%	Sufflex HS12L	526/A	B
C.28	4000p	± 10%	Dubilier 400	513/C	B
C.29	4000p	± 10%	Dubilier 400	513/C	B
C.30	1500p	± 20%	Dubilier 400	515/N	B
C.31	1500p	± 20%	Dubilier 400	515/N	B
C.32	.05μ	—	See R45	—	C
C.33	.05μ	—	See R45	—	C
C.34	.02μ	—	Hunts B807	505/A	A
C.35	.02μ	—	Hunts B807	505/A	A
L.1			Acoustical Spec. No. 1023	—	B
L.2			Acoustical Spec. No. 1023	—	B
V.1			Mullard EF86	—	A and B
V.2			Mullard EF86	—	A and B
V.3			Mullard ECC83	—	A and B
V.4			Mullard ECC83	—	A and B
L.P.1			Osram Type OS76 6.3v .115A 11mm MES Round	690/J	C

## QUAD II POWER AMPLIFIER COMPONENTS LIST

Circuit No.	Value	Tolerance	Makers Ref.	Stock No.	Layout Photograph
R.1	1.5M	± 10%	Erie 9	160C	D
R.2	1.M	± 10%	Erie 8	165B	D
R.3	1.M	± 10%	Erie 8	165B	D
R.4	680	± 10%	Erie 8	261B	D
R.5	180K	± 5%	Erie 8	190D	D
R.6	180K	± 5%	Erie 8	190D	D
R.7	680K	± 10%	Erie 8	170C	D
R.8	2.7K	± 10%	Erie 8	248C	D
R.9	680K	± 10%	Erie 8	170C	D
R.10	100	± 5%	Erie 109	305E	D
R.11	470	± 5%	Erie 109	270D	D
R.12	180	± 5%	Dubilier A1/1	290A	D
C.1	.1mF	± 20%	Hunts A300	495D	D
C.2	.1mF	± 20%	Hunts B406P	495B	D
C.3	.1mF	± 20%	Hunts B406P	495B	D
C.4	16mF	- 20% + 50%	TCC (Etched Foil Section with C6)	469A	D
C.5	25mF	- 20% + 100%	Hunts MEW29	465B	D
C.6	16mF	- 20% + 50%	TCC (Plain Foil Section with C4)	469A	D

Circuit No.	Value	Tolerance	Makers Ref.	Stock No.	Layout Photograph
V.1			Mullard EF86		D
V.2			Mullard EF86		D
V.3			G.E.C. KT66		D
V.4			G.E.C. KT66		D
V.5			Mullard GZ32		D
T.1			Output Transformer Spec. No. 1003A		D
T.2	200 - 250V		Mains Transformer Spec. No. 1001		D
T.2	95 - 125V		Mains Transformer Spec. No. 1008		D
L.1			Choke Spec. No. 1002		D
F.S.1	200 - 250V		2A $1\frac{1}{4}$ x $\frac{1}{4}$ Belling Lee L1055	675E	D
F.S.1	95 - 125V		3A $1\frac{1}{4}$ x $\frac{1}{4}$ Belling Lee L1055	675D	D

## QUAD 22 CONTROL UNIT SPECIFICATION

### FREQUENCY RESPONSE

Cancel position:

Radio and Tape inputs: 20-20,000 c/s  $\pm$  0.5 dB.

Microphone: 20-20,000 c/s  $\pm$  2 dB.

Gramophone: Maintained over 20-20,000 c/s within  $\pm$  1 dB of the following characteristics:

	3180 $\mu$ S	318 $\mu$ S	75 $\mu$ S
	3180 $\mu$ S	318 $\mu$ S	100 $\mu$ S
	3180 $\mu$ S	450 $\mu$ S	50 $\mu$ S
	— $\mu$ S	450 $\mu$ S	25 $\mu$ S

Bass and treble controls:  $\pm$  1.5 dB of published curves.

Filter frequencies: 5 Kc/s, 7 Kc/s, 10 Kc/s.

Filter slope: See curves.

### INPUT SENSITIVITY (at 1 Kc/s for 1.4 Vrms output)

Radio: 70 mVrms, load impedance 100,000 ohms.

Tape: Depending upon adaptor unit.

Microphone: 1.5 mVrms, load impedance 100,000 ohms.

Pick-up: Depending upon adaptor unit. Basic sensitivity prior to compensation 400  $\mu$ Vrms.

### DISTORTION (1.4 Vrms output):

All controls level: Any input: 0.02%.

Least favourable arrangement of controls: less than 0.1%.

### NOISE

Total hum and noise: Better than -70 dB.

Noise: -80 dB or where applicable, the equivalent noise of the pick-up load impedance at the input.

### OUTPUT

Control unit to power amplifier: 1.4 Vrms.

Tape outputs: Maximum signal approx. 0.25 Vrms.

Maximum loading 500,000 ohms and 200 pF.

### INTERCHANNEL SPECIFICATION

Cross talk: Better than 40 dB 20-20,000 c/s.

Gain stability: With any volume setting and tone controls level: Less than 1 dB between channels.  
With any volume setting and tone controls varied: Less than 2dB between channels.

Balance control: Provides up to 9 dB unbalance either way.

### POWER SUPPLY

The unit takes its power from the power amplifier as follows:—

330 V 4mA. }  
6.3 V 1.1 A. } Plus current taken by tuner units.

Maximum power available from tuner sockets:

330 V 35 mA each tuner.

Rad. 1 and Rad. 2: 6.3 V 3 A total.

Rad. 1 (2nd channel): 6.3 V 3 A.

The heater supply is C.T. to chassis.

### VALVES

2 x EF86 (Z.729 or 6267).

2 x ECC83 (12AX7).

## QUAD II POWER AMPLIFIER SPECIFICATION

*Figures for response, distortion, sensitivity and background are the pass figures on final test*

### POWER OUTPUT

15 watts throughout the range 20-20,000 c/s.

### FREQUENCY RESPONSE

Within 0.2 dB 20-20,000 c/s.

Within 0.5 dB 10-50,000 c/s.

### DISTORTION (measured at 12 watts output).

Total 3rd and higher order: less than 0.1% at 700 c/s.

Higher order alone: less than 0.03% at 700 c/s.

Valve mismatching up to 25% (introducing 2nd harmonic) not to cause distortion to exceed 0.18%. Total distortion at 50 c/s not to exceed 0.25%.

### INPUT

Sensitivity: 1.4 Vrms for 15 watts output.

Load imposed on input: 1.5 Megohms in parallel with 10 pF.

### BACKGROUND

80 dB referred to 15 watts.

### OUTPUT IMPEDANCES 15 ohm and 7 ohm.

Effective output resistance: 1.5 ohm for 15 ohm output

### POWER SUPPLIES

INPUT: 200-250 V. AC single phase (or 95-125 V. AC)  
40-80 c/s.

90 watts consumption (excluding control unit, tuners, etc.)

HT AND LT supplies available for external equipment:

330 V. 40 mA.

6.3 V. 4 A. (heater C.T. to chassis).

VALVES 2 x EF.86 (Z.729 or 6267), 2 x KT.66, 1 x GZ.32  
(54KU. or 5V4G).

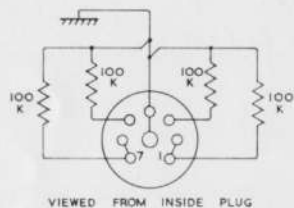

MIC N

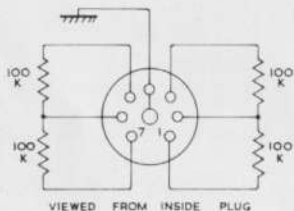

TAPE N

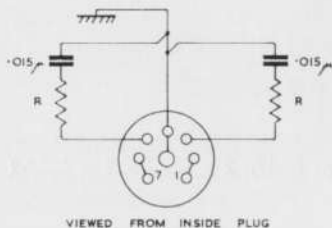

TAPE H

TAPE INPUT ADAPTOR UNITS

<i>Adaptor Type</i>	<i>Tape Input Sensitivity at 1,000 c/s</i>	<i>Load resistance presented by amplifier</i>	<i>Response</i>
MIC N	1.5 mV	*00,000 ohms	Level
TAPE N	70 mV	100,000 ohms	Level
TAPE H1	6 mV	1.5 megohms	100 $\mu$ Sec CCIR 7 $\frac{1}{2}$ " / Sec replay characteristic.
TAPE H2	7 mV	1.5 megohms	50 $\mu$ Sec NAB 7 $\frac{1}{2}$ " and 15" / Sec replay characteristic.
TAPE H3	7 mV	1.5 megohms	35 $\mu$ Sec CCIR 15" / Sec replay characteristic.

Component Values for Tape H Adaptors

TAPE H1 R = 6,800 ohms

TAPE H2 R = 3,300 ohms

TAPE H3 R = 2,200 ohms

## Component List for Pickup Adaptor Units

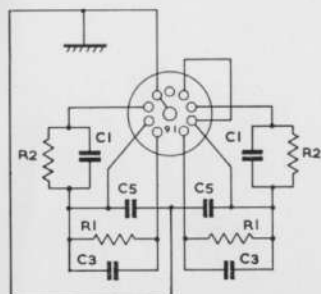

VIEWED FROM INSIDE PLUG

**SINGLE LETTER ADAPTOR**

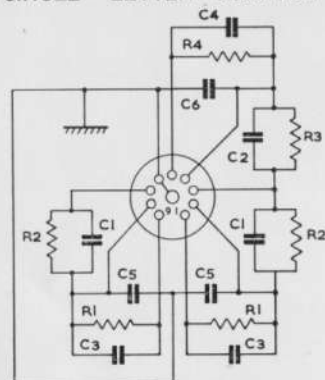

VIEWED FROM INSIDE PLUG

**DOUBLE LETTER ADAPTOR**

	R1	R2	R3	R4	C1	C2	C3	C4	C5	C6
A	68K	—	—	—	180p	—	—	—	1000p	—
AA	68K	—	—	68K	180p	180p	—	—	1000p	1000p
AB	68K	—	10M	68K	180p	560p	—	—	1000p	—
AE	68K	—	330K	1.5M	180p	1000p	—	47p	1000p	—
B	68K	10M	—	—	560p	—	—	—	—	—
BA	68K	10M	—	68K	560p	180p	—	—	—	1000p
BB	68K	10M	10M	68K	560p	560p	—	—	—	—
BE	68K	10M	330K	1.5M	560p	1000p	—	47p	—	—
E	1.5M	330K	—	—	1000p	—	47p	—	—	—
EA	1.5M	330K	—	68K	1000p	180p	47p	—	—	1000p
EB	1.5M	330K	10M	68K	1000p	560p	47p	—	—	—
EE	1.5M	330K	330K	1.5M	1000p	1000p	47p	47p	—	—
F	2.2M	1M	—	—	330p	—	33p	—	—	—

*Adaptor type*

A  
B  
E  
F

*Pickup input sensitivity at 1,000 c/s*

4 mV  
10 mV  
300 mV  
150 mV

*Load resistance presented by amplifier*

68,000 ohms  
68,000 ohms  
1.5 Megohms  
2.2 Megohms

*Note:* This information applies to either stereo or monaural channels according to whether the first or second letter of the type is considered.



## QUAD 22 CONTROL UNIT

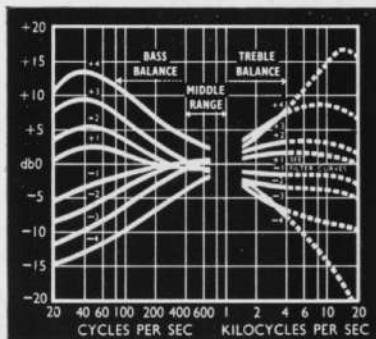

Curves showing (left) effect of bass and treble controls, and (below) extended frequency response and effect of the 7K filter.

## QUAD II POWER AMPLIFIER

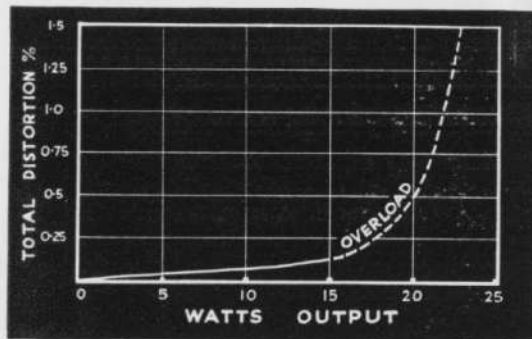

Linearity and overload of the QUAD II power amplifier

A multi-element low frequency filter rapidly attenuates the sub-audio frequencies without encroachment into the useful range making a switchable roll-off superfluous.

The high frequency filter curves shapes are accurately maintained and the figures adjacent to the curves are the approximate dial settings. The 5K and 10K filters provide similar curves one half octave up or down.

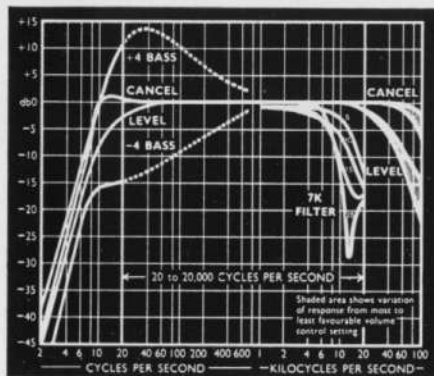

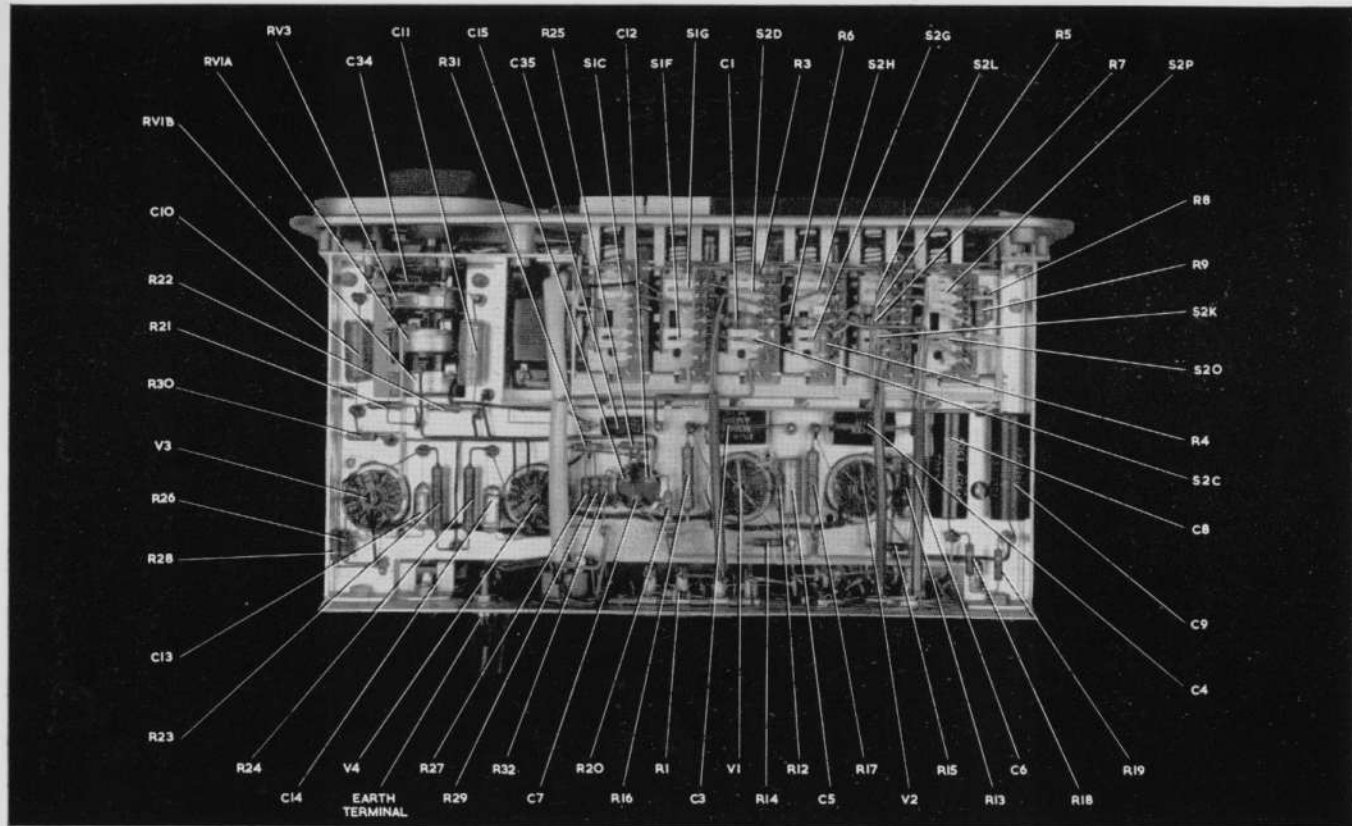

LAYOUT PHOTOGRAPH A

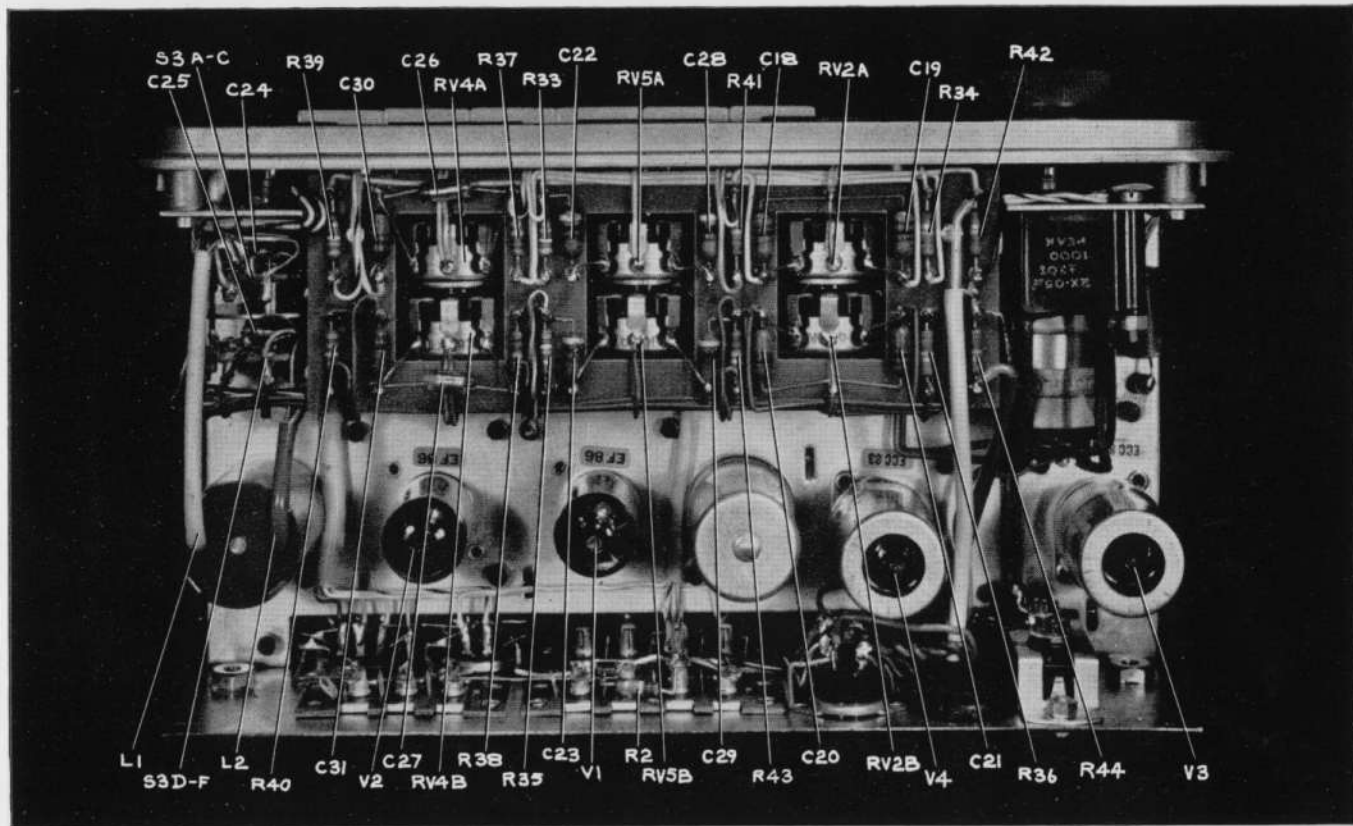

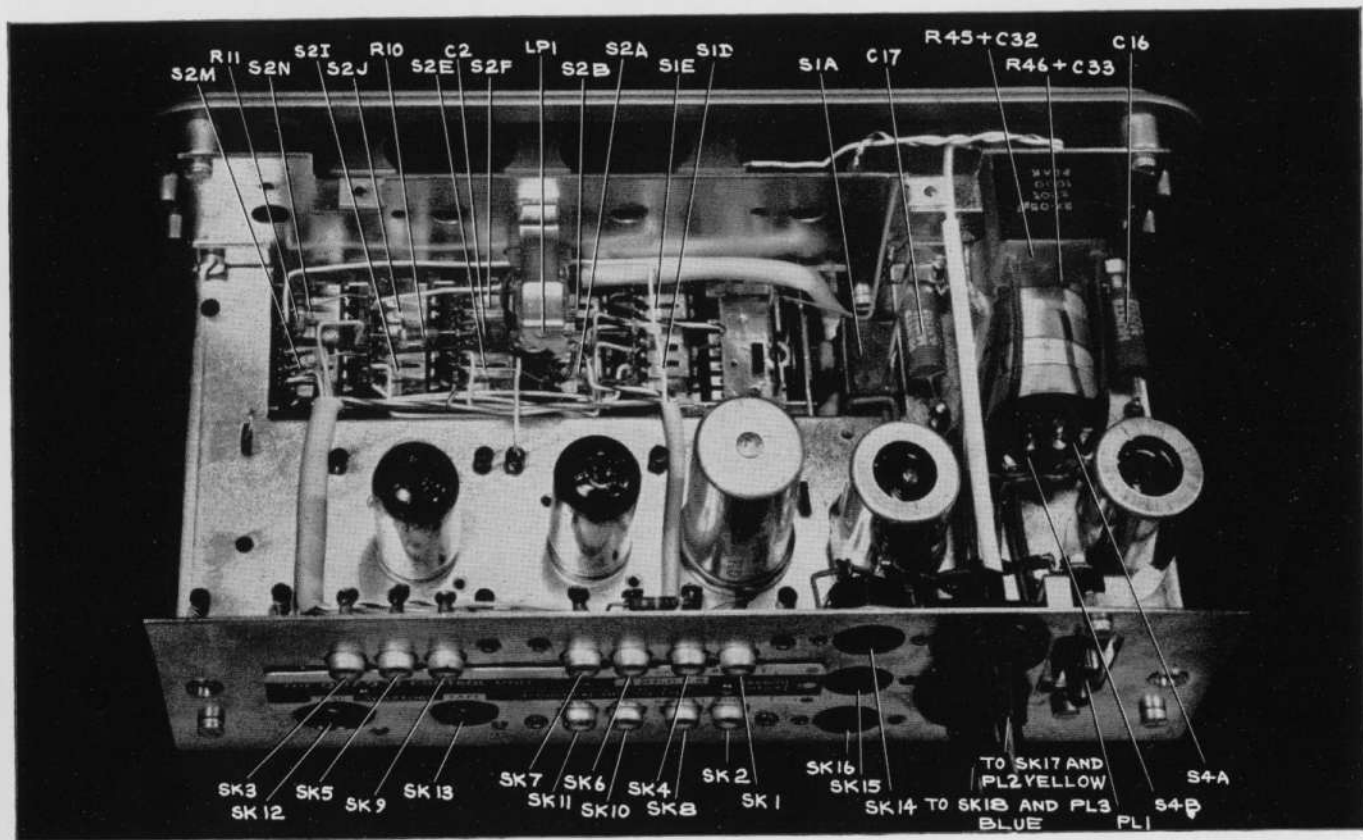

LAYOUT PHOTOGRAPH C

